

DANCOVER[®]



Manual
for
Polytunnel Greenhouse
4m Series

DANCOVER[®]

.com

Safety Advice

Attention

In some countries or areas, you may have to obtain permission when setting up structures like greenhouses or similar buildings exceeding a certain size. It is your responsibility to comply with local rules and regulations and to ensure that the greenhouse is assembled correctly.

Please note that your polytunnel greenhouse is intended as a seasonal form of coverage and not as a permanent structure! During windy weather, we advise you to secure your greenhouse or in case of strong wind, take it down. Overall, we advise you to place your polytunnel greenhouse in the lee of a building, trees or other objects that will protect the greenhouse from too strong and direct wind.

When it rains, water may pile up on top of your polytunnel greenhouse causing it to collapse. It is your responsibility to keep the roof of the greenhouse free of gathering water. Be sure that the cover is fully extended at all times and make sure to remove water that builds up during rainfall.

In case of bad weather in general, please secure loose objects in the garden, e.g. the garden trampoline and other things that may cause a danger for your polytunnel greenhouse. Furthermore, do not use open fire, welding equipment or other sources of ignition, inside or close to the greenhouse.

When you buy a greenhouse and set it up in your garden, we recommend that you check, whether your home insurance covers the structure. At the same time, you are not supposed to be inside the greenhouse during extreme weather conditions.

This structure has not been tested for specific snow and wind loads! Make sure you follow our general safety advice and in the event of snow, always remove excessive amounts of snow from the greenhouse to prevent too much snow on the roof of the greenhouse. Snow is likely to make the entire structure to collapse; hence our advice about seasonal use only.









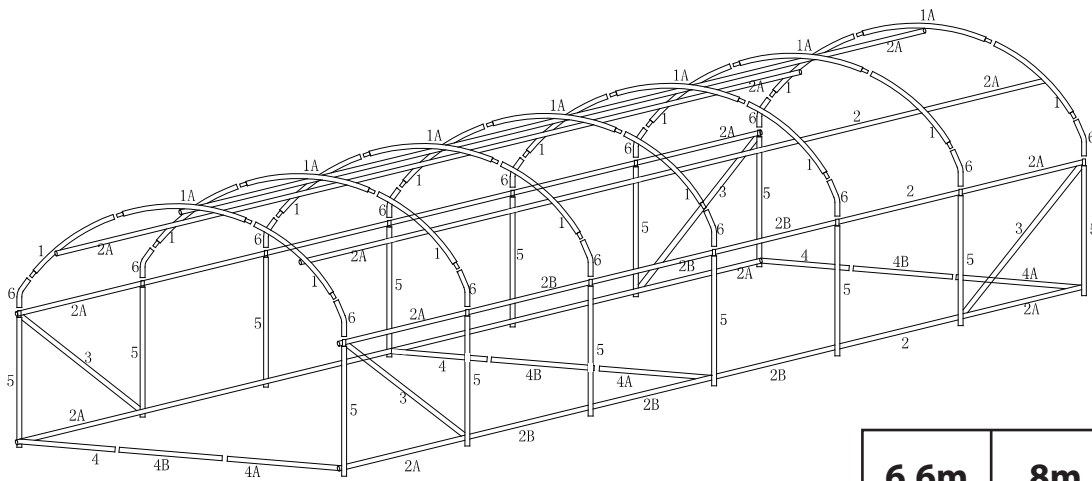



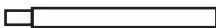

Note: Dancover warranty applies only to the normal use of the greenhouse, normal wear and tear excepted, by written use instructions or manual. The warranty does not apply to damage caused by accident, abuse, misuse or modification of the greenhouse.

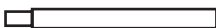
Warranty Information

Please visit dancovershop.com for information on warranty.

Please always check our website for the latest safety advice and manual.

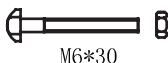
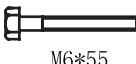
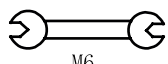

		6.6m	8m	10.6m
1#		12	14	18
1A#		6	7	9
2#		7	7	7
2A#		14	14	14
2B#		14	21	35
3#		4	4	4
4#		3	3	3
4A#		3	3	3
4B#		3	3	3
5#		12	14	18
6#		12	14	18
7	 M6*55	36	43	57
8	 M6*30	12	14	18
9	 M6*55	6	6	6
10	 M6	2	2	2
11		1	1	1

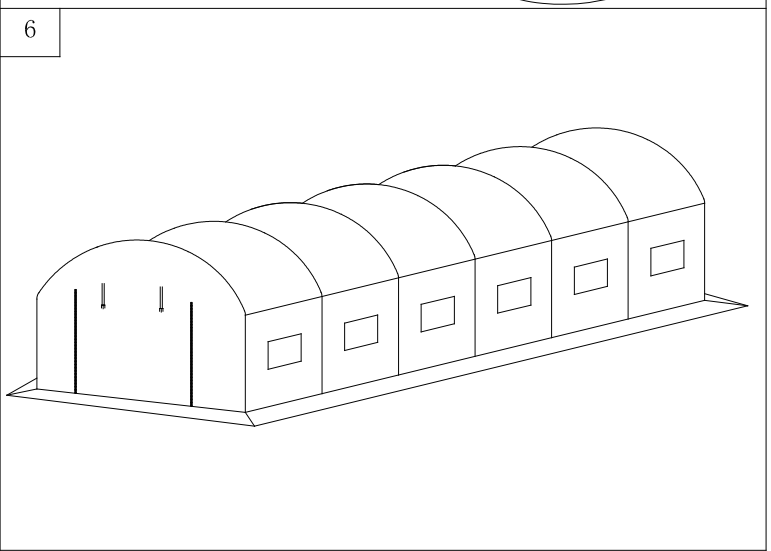
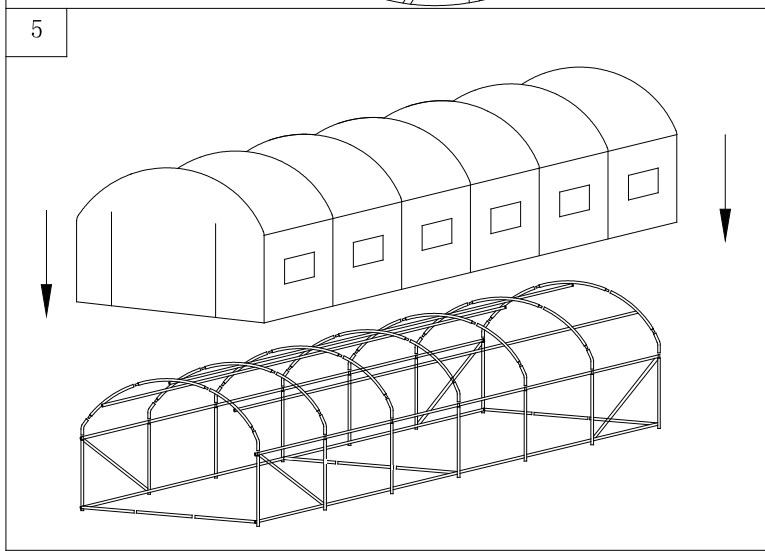
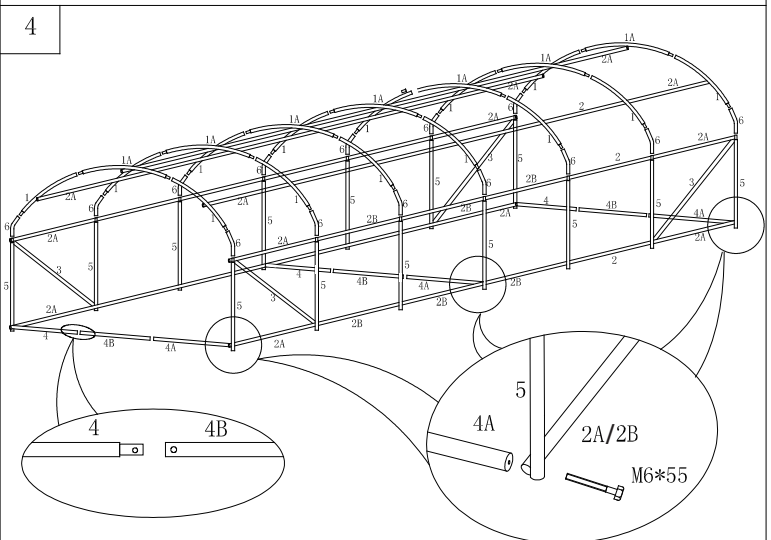
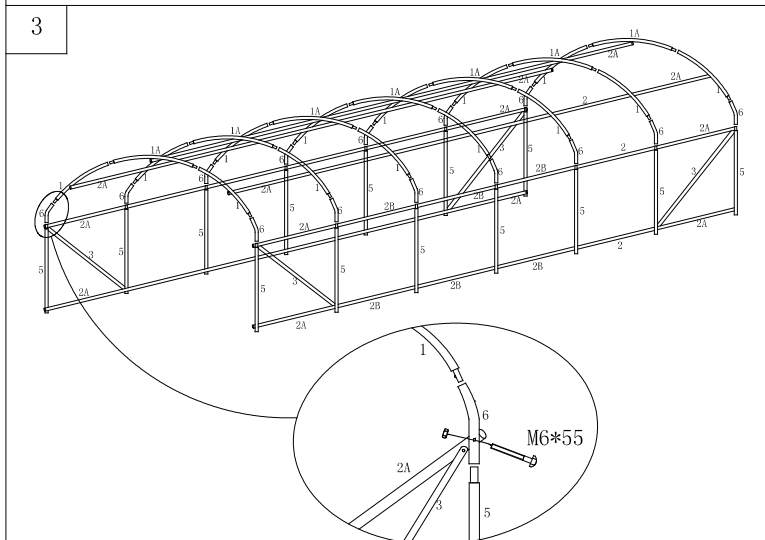
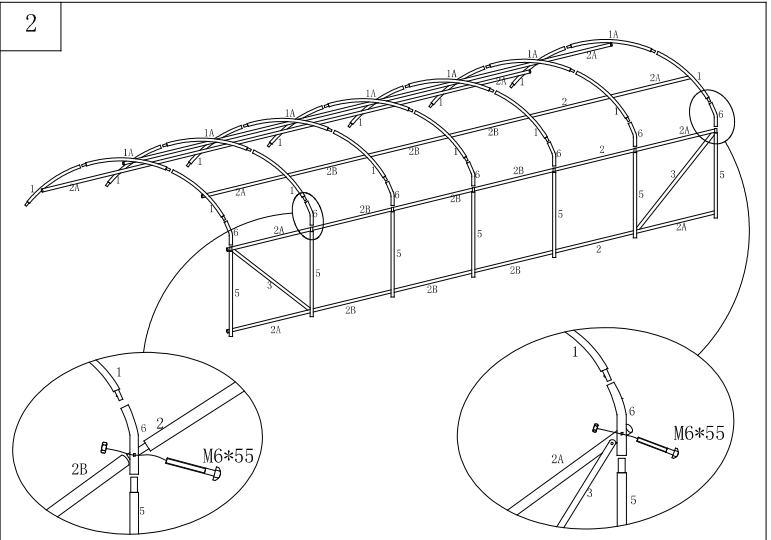
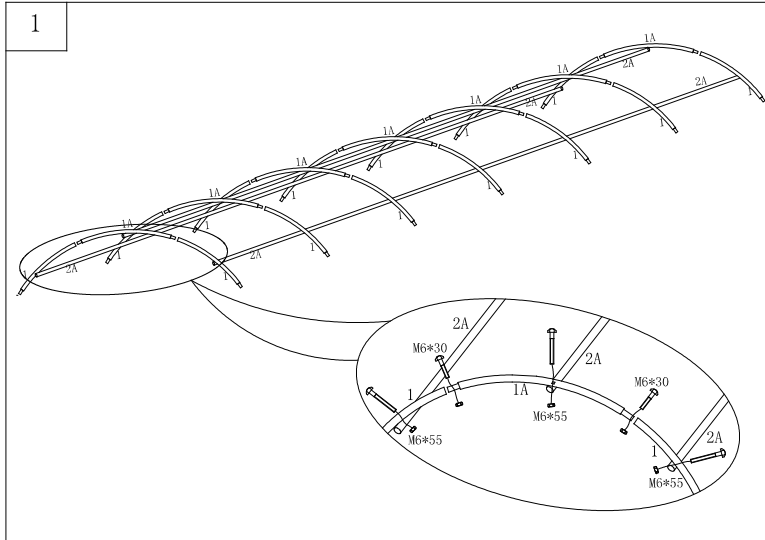

DANCOVER[®]

.com

Contact information

Head office:

Dancover A/S
Nordre Strandvej 119 G
3150 Hellebæk
Denmark

For more information
please visit:
www.dancovershop.com

National contact

Denmark: 70 26 76 20
denmark@dancover.com

UK: 020 8099 7570
uk@dancover.com

Germany: 041 0266 7040
germany@dancover.com

France: 0975 181 800
france@dancover.com

Sweden: 040 233 262
sverige@dancover.com

Finland: 0 931 581 720
suomi@dancover.com

Poland: 22 300 8602
polska@dancover.com

Luxembourg: +49 041 0266 7040
luxembourg@dancover.com

Portugal: 308 800 899
portugal@dancover.com

Spain: 911 436 828
espana@dancover.com

Italy: 02 479 21 198
italia@dancover.com

Switzerland: 0840 000125
schweiz@dancover.com

Austria: 0662 626935
austria@dancover.com

Norway: 231 00 690
norge@dancover.com

Nederland: 0 858 880 524
nederland@dancover.com

Ireland: 0 151 33 003
ireland@dancover.com

Belgium: 0 28 08 08 09
belgique@dancover.com