

**DANCOVER<sup>®</sup>**

**.com**

Manual  
for  
Marquee  
Multipavillon  
6x9m

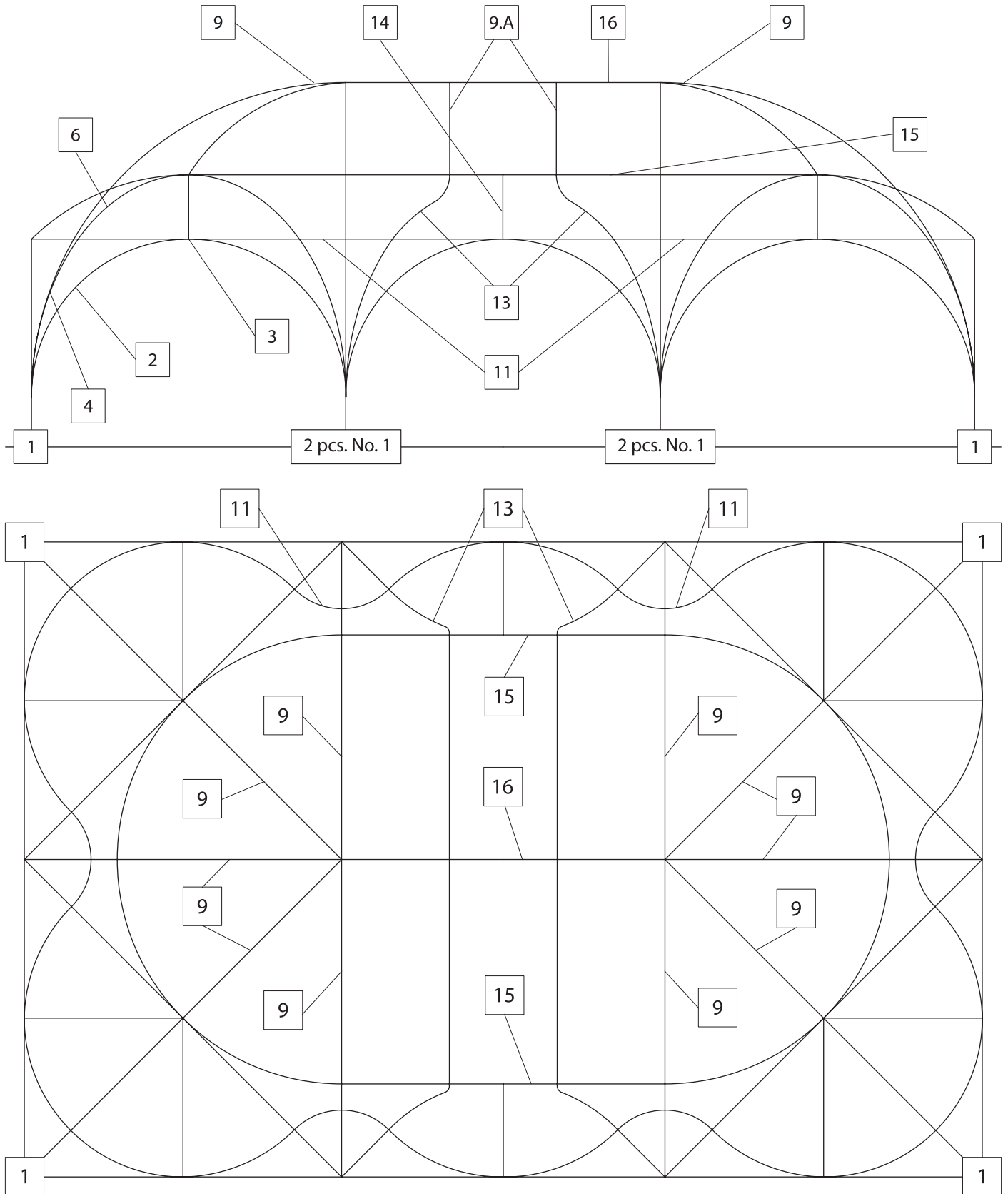















# ASSEMBLY INSTRUCTION



**It is easy to assemble  
your marquee  
Multipavillon**

## Each package must contain

No. 1	No. 2	No. 3	No. 4	No. 5	No. 6	No. 7	No. 8	No. 9	No. 9A	No. 10	No. 11	No. 12	No. 13	No. 14	No. 15	No. 16
16 pcs.	20 pcs.	10 pcs.	16 pcs.	22 pcs.	20 pcs.	2 pcs.	16 pcs.	10 pcs.	4 pcs.	6 pcs.	6 pcs.	4 pcs.	4 pcs.	2 pcs.	2 pcs.	1 pcs.

No. 1		Base
No. 2		Entrance tube
No. 3		Small horizontal tube
No. 4		Small corner tube
No. 5		Cross fitting
No. 6		Small top tube
No. 7		Top fitting
No. 8		Ground pegs
No. 9		Large top tube
No. 10		Large corner tube
No. 11		Small curved tube
No. 12		Large horizontal tube
No. 13		S-tube
No. 14		Small oblique tube
No. 15		Straight tube w/ 3 fittings
No. 16		Straight tube w/ 2 fittings

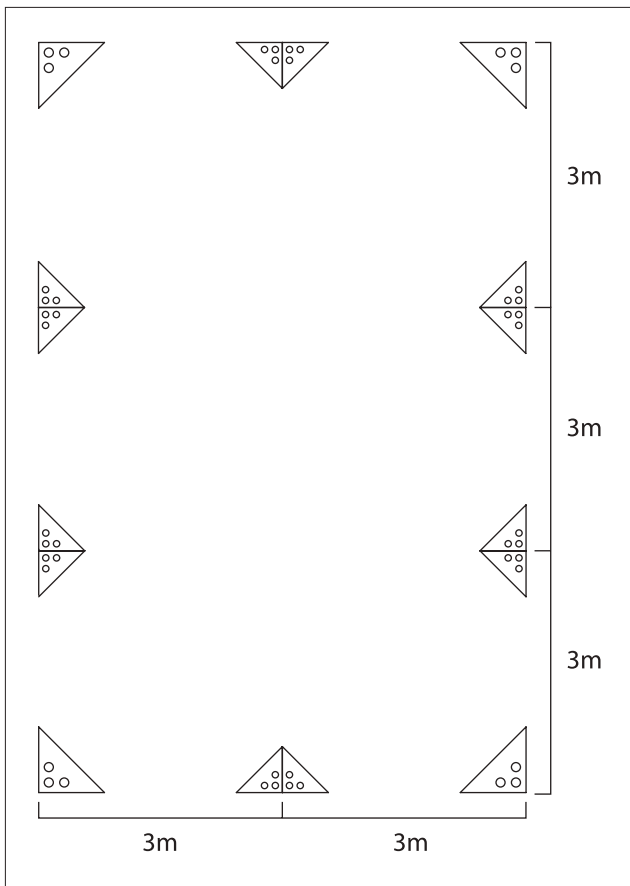

Place the 16 corner bases (1) as shown on drawing so they form a frame measuring 6x9 m.

If the marquee is mounted outside use ground pegs (8) inserted into the ground with a hammer.

If the marquee is mounted on a concrete or wooden floor, the corner base can be fastened with concrete nails or screws.

Fasten only one corner until the entire frame has been assembled in order to ensure that the other corner bases are placed correctly within the square.

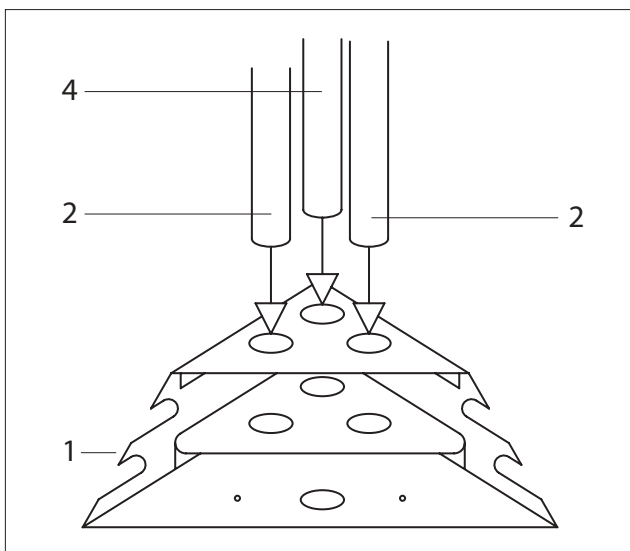

Place the longest tubes (2) in the 2 outermost holes in each corner base and the shorter tube (4) in the middle hole. Mount the tubes so the snap-and-click features points upwards.

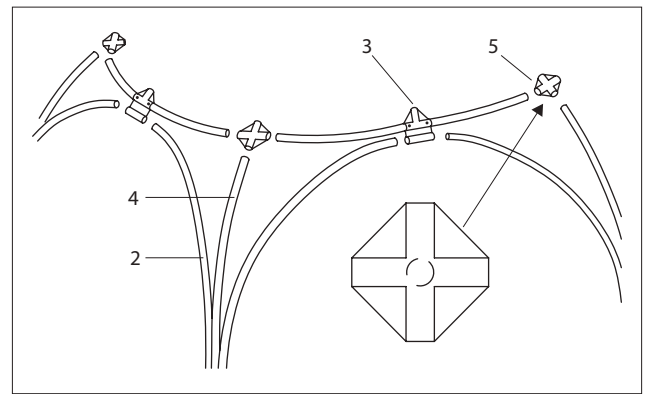

Mount the tubes (2) in (3) for a complete arch. Mount the connector (5) with the middle tube (4). Mount the horizontal tubes (3) with the connectors (5) to make a ring.

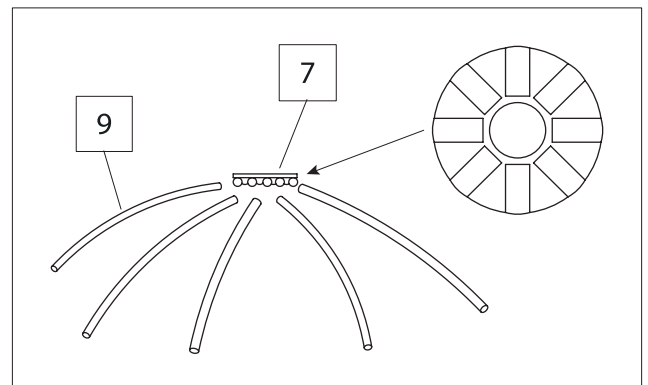

Assemble and mount the top section consisting of (9) and (7).

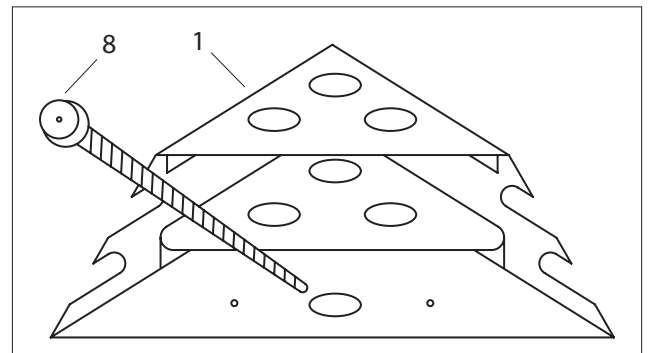

Now you can fasten the remaining corner bases if necessary.

Finally, mount to cover onto the frame. Fasten the 4 straps at the ends of the cover to the 4 corner bases.

## Contact information

### Head office:

Dancover A/S  
Nordre Strandvej 119 G  
3150 Hellebæk  
Denmark

For more information  
please visit:  
[www.dancovershop.com](http://www.dancovershop.com)

## National contact

Denmark: 70 26 76 20  
[denmark@dancover.com](mailto:denmark@dancover.com)

UK: 020 8099 7570  
[uk@dancover.com](mailto:uk@dancover.com)

Germany: 041 0266 7040  
[germany@dancover.com](mailto:germany@dancover.com)

France: 0975 181 800  
[france@dancover.com](mailto:france@dancover.com)

Sweden: 040 233 262  
[sverige@dancover.com](mailto:sverige@dancover.com)

Finland: 0 931 581 720  
[suomi@dancover.com](mailto:suomi@dancover.com)

Poland: 22 300 8602  
[polska@dancover.com](mailto:polska@dancover.com)

Luxembourg: +49 041 0266 7040  
[luxembourg@dancover.com](mailto:luxembourg@dancover.com)

Portugal: 308 800 899  
[portugal@dancover.com](mailto:portugal@dancover.com)

Spain: 911 436 828  
[espana@dancover.com](mailto:espana@dancover.com)

Italy: 02 479 21 198  
[italia@dancover.com](mailto:italia@dancover.com)

Switzerland: 0840 000125  
[schweiz@dancover.com](mailto:schweiz@dancover.com)

Austria: 0662 626935  
[austria@dancover.com](mailto:austria@dancover.com)

Norway: 231 00 690  
[norge@dancover.com](mailto:norge@dancover.com)

Nederland: 0 858 880 524  
[nederland@dancover.com](mailto:nederland@dancover.com)

Ireland: 0 151 33 003  
[ireland@dancover.com](mailto:ireland@dancover.com)

Belgium: 0 28 08 08 09  
[belgique@dancover.com](mailto:belgique@dancover.com)