

**DANCOVER<sup>®</sup>**



PARTY TENT SEMI PRO

5m series

# DANCOVER<sup>®</sup>



## Safety Advice

### Attention

In some countries approval is needed to set up a marquee/tent larger than 75 m<sup>2</sup>. It is your responsibility to comply with local rules and regulations and to ensure that the marquee/tent is assembled correctly.

In case of bad weather conditions, it is your responsibility to ensure the marquee/tent is safely secured and that the marquee/tent does not cause damage to others.

Do not use open fire, welding equipment or other sources which can ignite, inside or close to the tent.

The marquee/tent must be safely secured. We recommend you secure your marquee/tent with straps and pegs as soon as it is assembled.

Make sure to check if the marquee/tent is covered by your home contents insurance.

Marquees/tents must be evacuated under extreme weather conditions.

In the event of snow always remove snow from the roof of the marquee/tent regularly to prevent snow from building on the roof as heavy snow can cause the marquee/tent to collapse.

In the event of rain there is a risk of rain puddles building up on top of the roof of the marquee/tent. Heavy rain puddles can cause the roof to collapse. It is your responsibility to ensure rain puddles do not build up. As a precaution, make sure the roof of the marquee/tent is stretched out properly and adequately over the side frames of the marquee/tent and remove rain water regularly.

Do not unpack or repack your marquee/tent in freezing temperatures. In case of temperatures below zero always unpack and repack your marquee/tent indoors to avoid the risk of cracking parts.

The marquee/tent must be totally dry before you repack and store it to avoid mildew.

Note: Marquees are intended for events and other arrangements and are as such only meant for short term temporary assembly and the following disassembly. Dancover warranty applies only to the normal use of the Product, normal wear and tear excepted, in accordance with written use instructions or manual. The warranty does not apply to damage caused by accident, abuse, misuse, or modification of the Product.

### Warranty Information

Please visit [dancovershop.com](http://dancovershop.com) for information on warranty.

*Please always check our website for the latest safety advice and manual.*

## **Warning**

1

The pipes are covered in oil. Before you set up your tent please remove the oil carefully to keep the cover clean.

2

Take note that the tent needs to be handle with care to avoid damages.

3









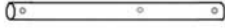

Do not force the frame as they may be damage in the process.

4









Tents are meant as temporary shelters and must be evacuated under extreme weather conditions.

Please select a suitable site for the tent to avoid damage to underground sprinkler systems, water, gas or electrical lines.



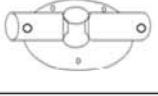



## 5m -2.3 PARTY TENT SEMI PRO

Dimension		NO	5x6	5x8	5x10	5x12	5x14
Pipe 2188mm 50-50 with holes		1	4	6	8	10	12
Pipe 1880mm 38-38		2	15	20	25	30	35
Pipe 1880mm 38-38 with hole		3-1	2	2	2	2	2
		3-2	2	2	2	2	2
Pipe 1940mm 50-50		4	8	10	12	14	16
Pipe 435mm 50-50		5	8	10	12	14	16
Pipe 1174 mm 25-25		6	4	4	4	4	4
Pipe 880mm 38-38		7	2	2	2	2	2
Pipe 2188mm 50-50 with holes and a hole		8	4	4	4	4	4
connector two way		9	8	10	12	14	16
connector Three way 110°54-42		10	4	4	4	4	4
connector Three way 140°54-42		11	2	2	2	2	2

## 5m -2.3 PARTY TENT SEMI PRO

connector four way 140 °54-42		12	2	3	4	5	6
connector four way 110 °54-42		13	4	6	8	10	12
Connector three way –foot for the corners 54-42		16	2	2	2	2	2
Connector three way –foot for the corners 54-42		17	2	2	2	2	2
Connector three way –foot for the sidewalls 54-42		18	4	6	8	10	12
Connector three way –foot for the endwalls 54-42		19	4	4	4	4	4
Groundpegs		20	4	6	8	10	10
Screw hook		21	4	4	4	4	4
Groundpeg 6x300mm		22	8	10	12	14	16
Groundpeg 4x180mm		23	36	42	48	54	60

### 5m -2.3 PARTY TENT SEMI PRO

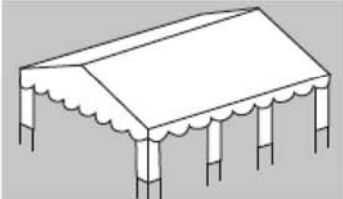
Screw M8X45mm		24	46	56	66	76	86
Screw M8X60mm		25	50	64	78	92	106
M8 Locknuts		26	96	120	144	168	192
spanner		31	1	1	1	1	1
Long bungeeball		33	88	106	124	142	160
rope		35	4	4	4	4	2
roof		37	1	1	1	1	1

## 5m -2.3 PARTY TENT SEMI PRO

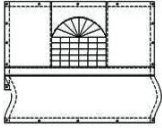
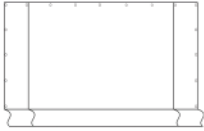
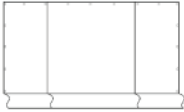
sidewall		38	6	8	10	12	14
endwall with large door		39	1	1	1	1	1
endwall with small door		40	1	1	1	1	1

## 5m -2.3 PARTY TENT SEMI PRO

I Select a flat surface for the tent.  
Unpack the boxes and check if all listed parts are included. Assemble the roof frame by mounting parts 9-13 on the pipes (Parts 2, 3-1, 3-2, 4 & 5). Use the screws to firmly attach the parts.

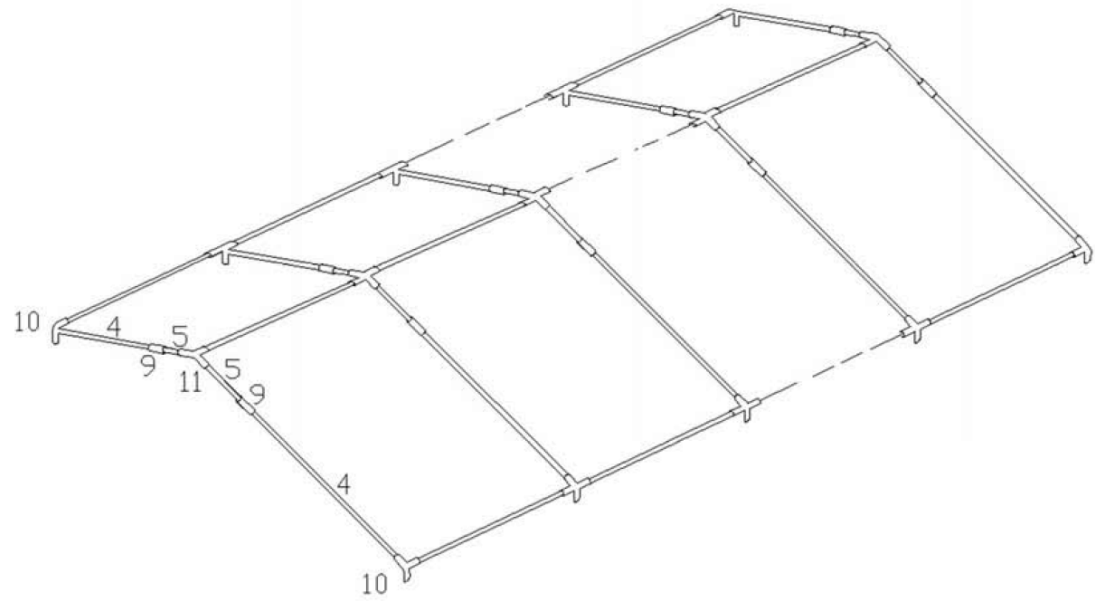
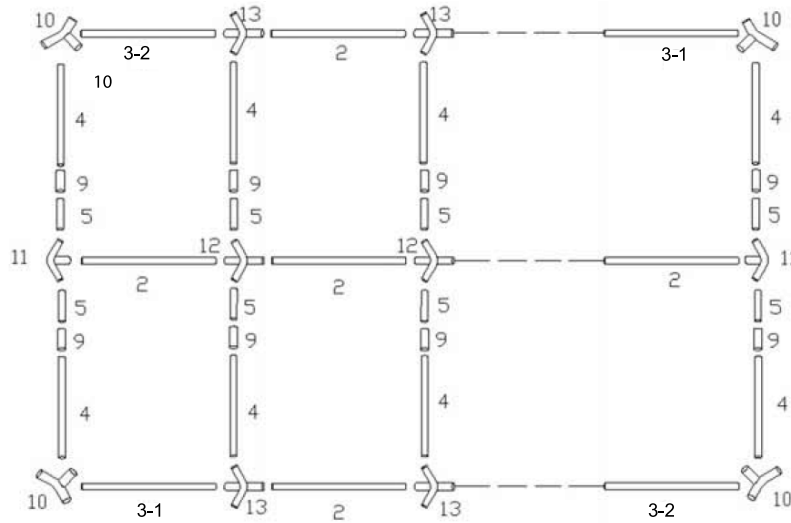



## 5m -2.3 PARTY TENT SEMI PRO

II

Lift one side of the tent frame and attach the legs(1). Attach the legs with part no. 8 to the outside in all four corners. Place the roof onto the frame and use the bungees to fasten it. Be sure not to put too much tension on the bungees in order not to make attaching the other side more difficult.

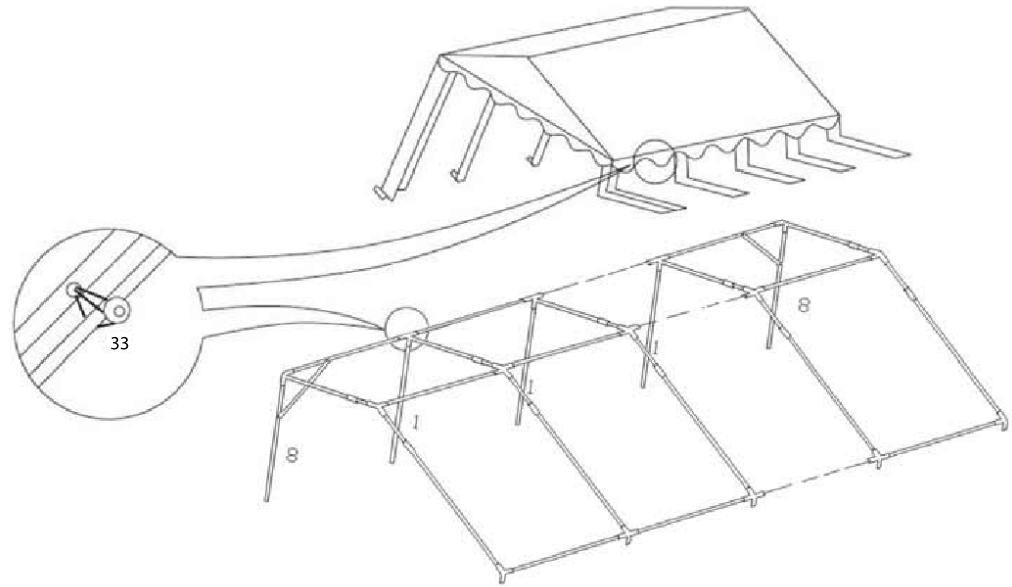

III

Attach the legs on the other side and install the feet(16,17,18,19) at the bottom. Use the long ground pegs to fasten the feet to the ground. Reinforce the side frame by attaching the diagonal pipes(6) to all four corners. Complete the bottom frame with the required pipes(2, 7) and connectors (16,17,18,19)

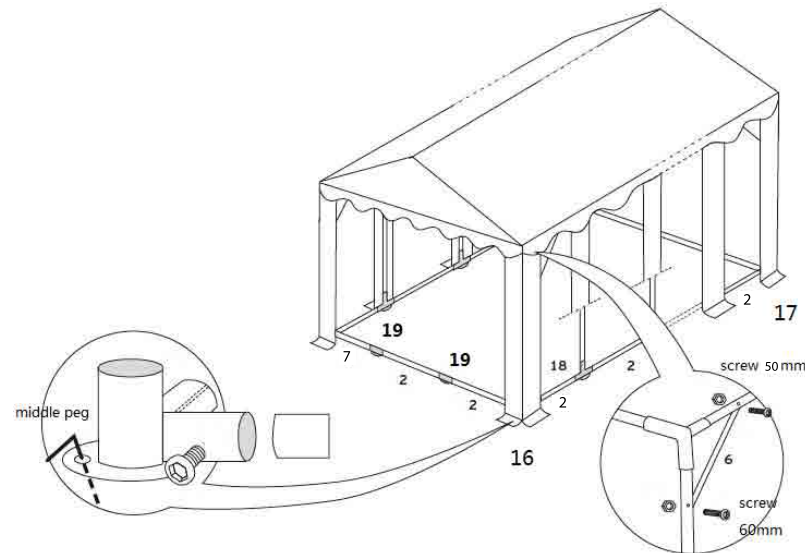

## 5m -2.3 PARTY TENT SEMI PRO

### IV

Attach the sidewalls to the frame using the bungees.

Attach the endwall directly to the roof with velcro.

Connect the leg covers to the sidewalls and endwalls with velcro as shown.

Use the short ground pegs to fasten the endwalls to the ground.

The guy rope runs from every corner of the tent and is braced to the ground using the spiral pegs.

The super pegs provide the tent with additional tension and stability

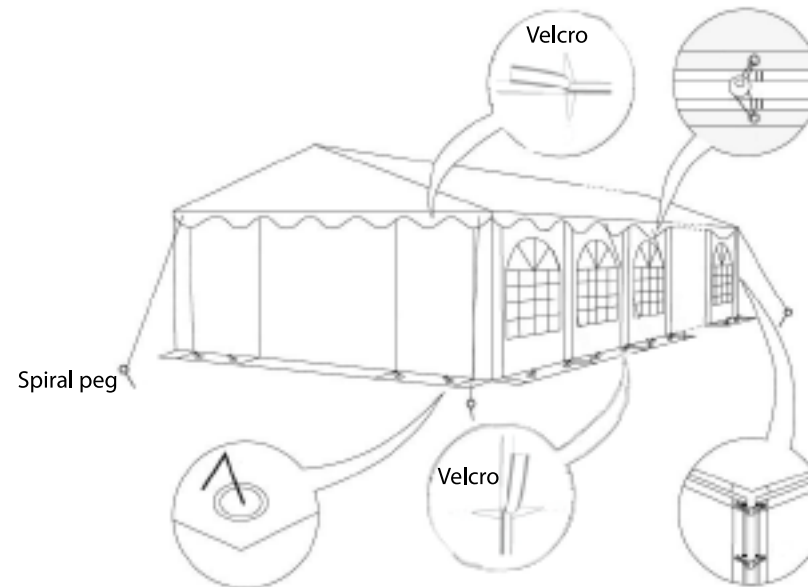

## Contact information

### Head office:

Dancover A/S  
Nordre Strandvej 119 G  
3150 Hellebæk  
Denmark

For more information  
please visit:  
[www.dancovershop.com](http://www.dancovershop.com)

## National contact

Denmark: 70 26 76 20  
[denmark@dancover.com](mailto:denmark@dancover.com)

UK: 020 8099 7570  
[uk@dancover.com](mailto:uk@dancover.com)

Germany: 041 0266 7040  
[germany@dancover.com](mailto:germany@dancover.com)

France: 0975 181 800  
[france@dancover.com](mailto:france@dancover.com)

Sweden: 040 233 262  
[sverige@dancover.com](mailto:sverige@dancover.com)

Finland: 0 931 581 720  
[suomi@dancover.com](mailto:suomi@dancover.com)

Poland: 22 300 8602  
[polska@dancover.com](mailto:polska@dancover.com)

Luxembourg: +49 041 0266 7040  
[luxembourg@dancover.com](mailto:luxembourg@dancover.com)

Portugal: 308 800 899  
[portugal@dancover.com](mailto:portugal@dancover.com)

Spain: 911 436 828  
[espana@dancover.com](mailto:espana@dancover.com)

Italy: 02 479 21 198  
[italia@dancover.com](mailto:italia@dancover.com)

Switzerland: 0840 000125  
[schweiz@dancover.com](mailto:schweiz@dancover.com)

Austria: 0662 626935  
[austria@dancover.com](mailto:austria@dancover.com)

Norway: 231 00 690  
[norge@dancover.com](mailto:norge@dancover.com)

Nederland: 0 858 880 524  
[nederland@dancover.com](mailto:nederland@dancover.com)

Ireland: 0 151 33 003  
[ireland@dancover.com](mailto:ireland@dancover.com)

Belgium: 0 28 08 08 09  
[belgique@dancover.com](mailto:belgique@dancover.com)