

DANCOVER[®]



Manual
for
Party PRO EventZone
9m Series

DANCOVER®

.com

Safety Advice

Attention

In some countries approval is needed to set up a marquee/tent larger than 75 m². It is your responsibility to comply with local rules and regulations and to ensure that the marquee/tent is assembled correctly.

In case of bad weather conditions, it is your responsibility to ensure the marquee/tent is safely secured and that the marquee/tent does not cause damage to others.

Do not use open fire, welding equipment or other sources which can ignite, inside or close to the tent.

The marquee/tent must be safely secured. We recommend you secure your marquee/tent with straps and pegs as soon as it is assembled.

Make sure to check if the marquee/tent is covered by your home contents insurance.

Marquees/tents must be evacuated under extreme weather conditions.

In the event of snow, always remove snow from the roof of the marquee/tent regularly to prevent snow from building on the roof, as heavy snow can cause the marquee/tent to collapse.

In the event of rain, there is a risk of rain puddles building up on top of the roof of the marquee/tent. Heavy rain puddles can cause the roof to collapse. It is your responsibility to ensure rain puddles do not build up. As a precaution, make sure the roof of the marquee/tent is stretched out properly and adequately over the side frames of the marquee/tent and remove rain water regularly.

Do not unpack or repack your marquee/tent in freezing temperatures. In case of temperatures below zero, always unpack and repack your marquee/tent indoors to avoid the risk of cracking parts.

The marquee/tent must be totally dry before you repack and store it to avoid mildew.

Note: Marquees are intended for events and other arrangements and are as such only meant for short term temporary assembly and the following disassembly. Dancover warranty applies only to the normal use of the Product, normal wear and tear excepted, in accordance with written use instructions or manual. The warranty does not apply to damage caused by accident, abuse, misuse, or modification of the Product.

Warranty Information

Please visit dancovershop.com for information on warranty.

Please always check our website for the latest safety advice and manual.

Contents

- 1. General**
- 2. Frames Assembling Guide**
- 3. 'Cover and Sidewalls' Assembling Guide**
- 4. Part list**
- 5. Fundamental**

1. General

Before assembling, workers should acquaint themselves with the safety precautions, necessary implements and materials.

● **Safety Precautions:**

- A. The supervisor needs at least 6 assistants to set up the tent.
- B. Before starting to work, the supervisor has to make his assistants familiar with the sequence of operations and safety precautions.
- C. He has to check that his assistants are qualified for this job and he is the responsible leader on the site.
- D. Everybody on the site should wear solid shoes and helmets.
- E. The site should be insulated. The people except the workers are not allowed to enter into the site.
- F. If the foundation soil is of an inferior quality, it is necessary to obviate foundation breaking danger by sufficient additional soil compression for expansion of the bearing surface.
- G. Pay attention that the site is free of circuit and that there are no cables or pipes under the ground.
- H. In case any cables or other electric equipment is installed in the tents, electrical operation rules should be strictly executed.
- I. Local safety precautions are applicable.
- J. Make sure the site is safe for the third party part. If the setup works is lasting for sections, safety measures should be taken in the nights.
- K. Tents fixing methods: In case of concrete ground and its heights exceeds 15cm, please use Swell Screws or weight bags. In case of grass ground, bitumen ground (any other soft grounds), please use steel Ground-Anchors.
- L. Please make sure the height difference of the site don't exceed 5cm, otherwise, it will affect the safety of the tent.

M. During or after the setup, if there is bad weather, especially when hailstone is reported by weather forecast, please dismantle the tent. If the snow depth is equal to or thicker than 3cm, please clean the snow on the roof. If the wind speed is equal to or faster than 80 Km/h, the tent has to be closed completely (all Roof-Cover, Gable-Cover, Sidewall & Gable Wall).

N. Any local regulations for temporary building are applicable.

O. In case of fire, please unfasten the Rope/Zipper on the wall or open the door to escape.

P. In case of any other special case, please contact the manufacturer for consultation.

● **Necessary Implements:**

Ladders, Spanners, Setup-ropes, Forks, Hammer, Pliers, Drills, a Protecting Foil or Carpet, Helmets, Solid shoes, Go-Cart, Pull-Up Peg Machine (if use the Ground-Anchors for tents fixing)

● **Necessary Materials:**

Please kindly find technical data in the packing list in the delivery.

1. Frames Assembling Guide

- **Measure the site and mark the tent position**
 - Please arrange the face line of one longitudinal side or the face line of the gable side
 - Then mark and stake the Base-Plates on the right position
- **Check the material list and put all of them on the right position for setup (Please find the packing list in the delivery - Techniques of the Tent)**

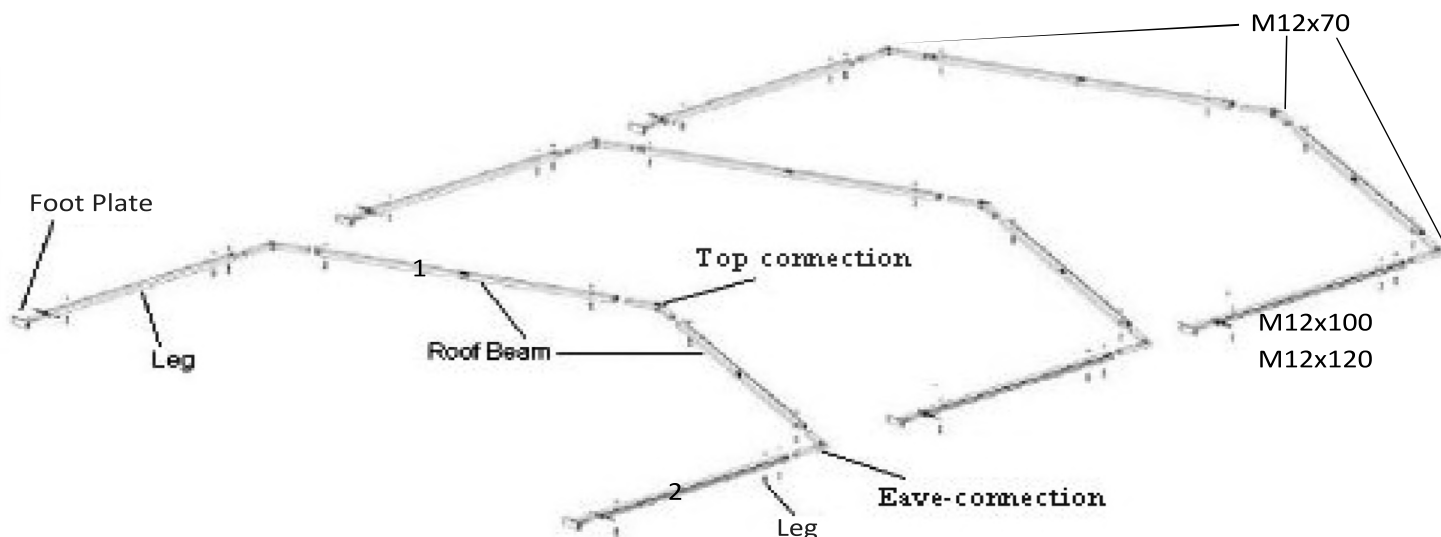

- Use the bolt(M12x70,M12x100,M12x120) to connect the Foot-Plates, Legs, Roof-Beams, Eave-Connections and Top Connections. And then, erect the first frame of the tent.

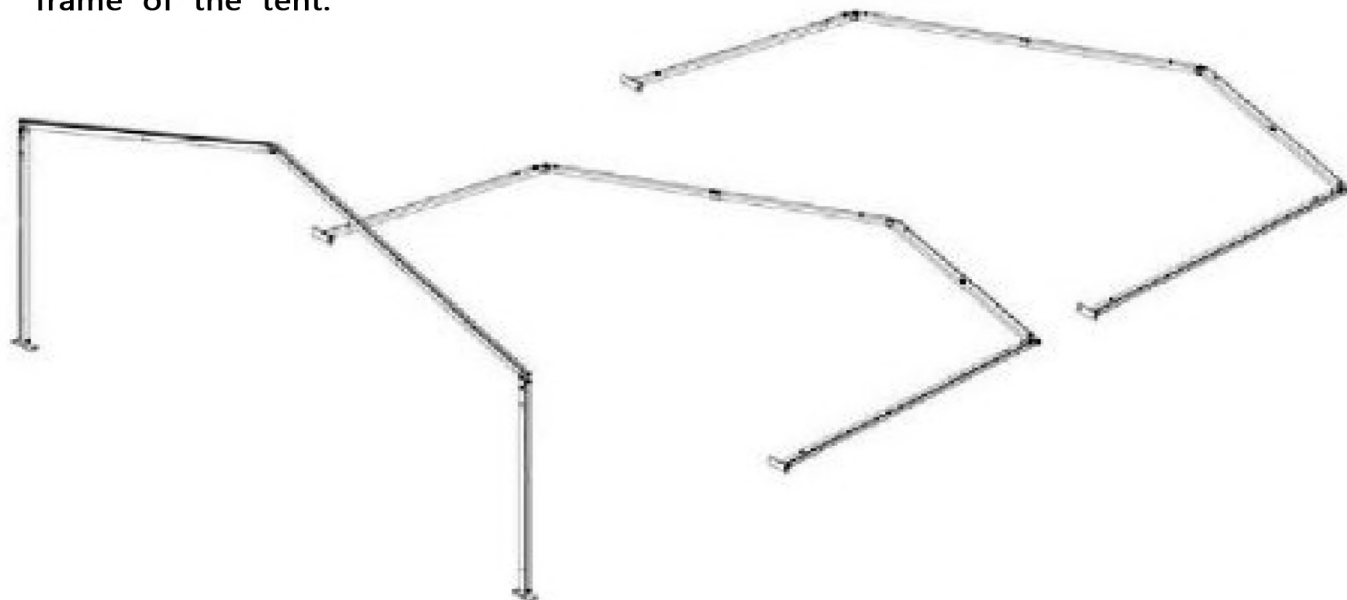

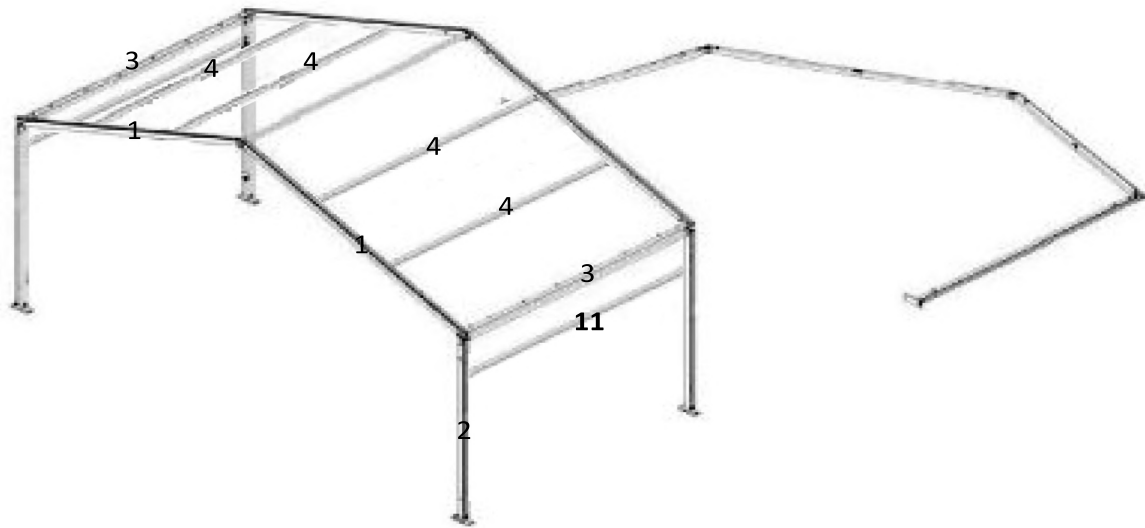

- **NO.11, Portal beams is on four corners for support. Use bolt M12x70 to fix it.**

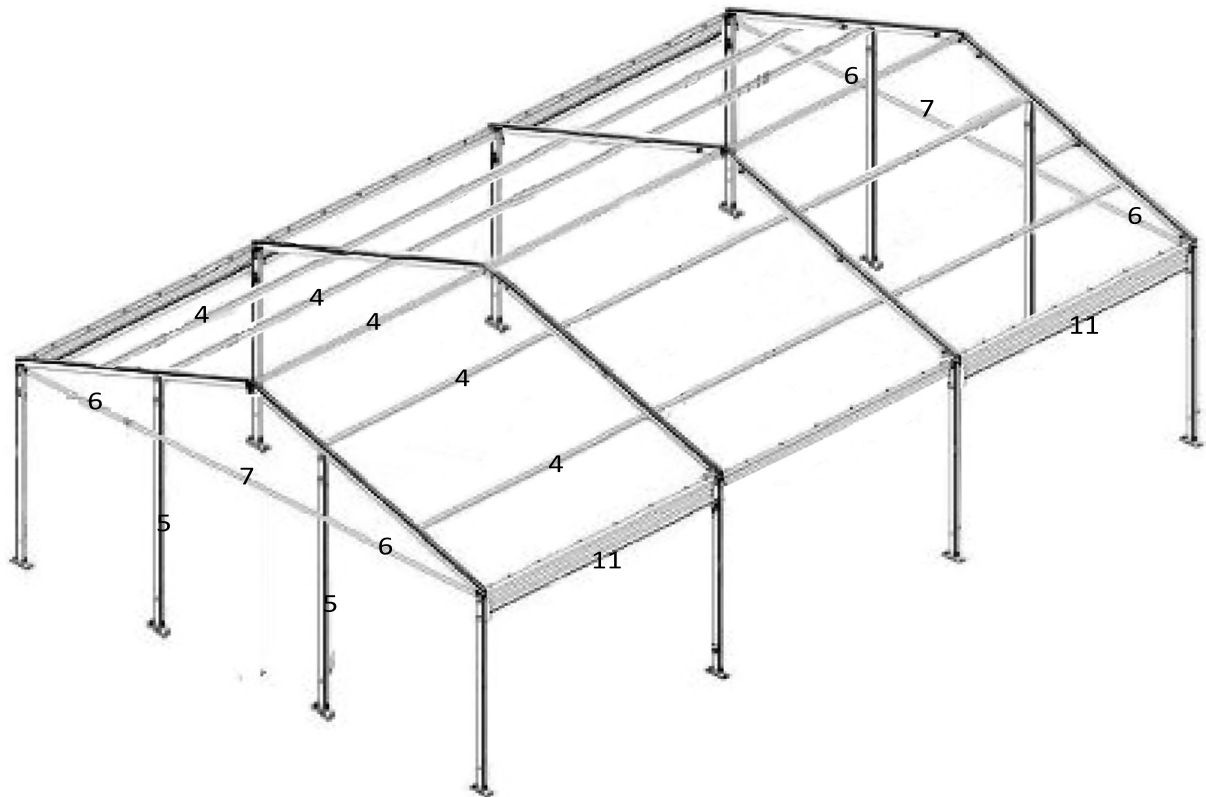

- **Erect all frames and put the purlins on the roof as the first section.**
- **Use bolt M12x70 to fix the leg NO.5 and Roof beam NO.1 through NO.31**
- **Use bolt M12x120 to fix the leg(NO.2,5) and Gable Purlin (NO.6,7).**
- **Use bolt M12x100 to fix Tie down on the leg NO.5**

2. 'Roof Cover and Sidewalls' Assembling Guide

● Roof-Cover

- Unpack the Roof-Cover and put it onto a protecting foil or carpet to avoid it getting dirty or damaged
- Throw 2 PCS of Setup-Ropes over the first unit of the tent
- Tie the Setup-Ropes with the straps inside of the Roof-Cover
- Lift the Roof-Cover up to the eaves and insert the Keder into the groves of the Roof-Beams
- Slowly pull in the Roof-Cover with equal force on both sides
- Pull in until the Roof-Cover reaches the opposite eaves
- Repeat the procedure until all Roof-Covers have been pulled on

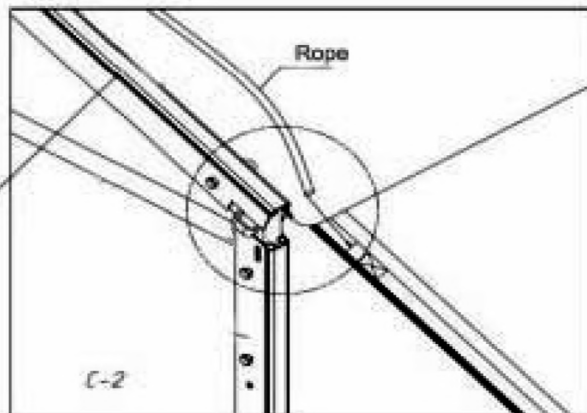
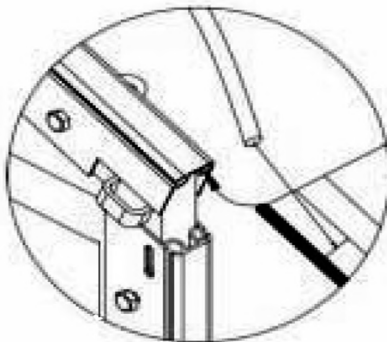
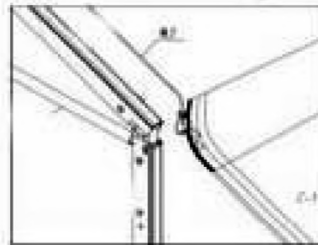
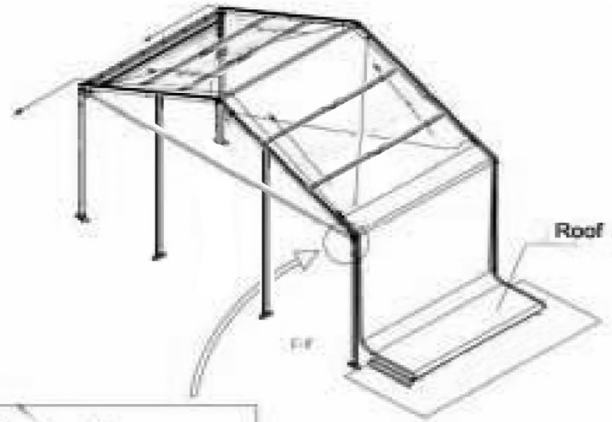

Caution:

The Roof-Cover has to be completely inserted into the groove of the Roof-Beam.



● **Gable Triangle**

- Divide the Gable-Cover into two pieces
- Insert each triangle into the Roof-Beam, starting from the eave
- Connect the two triangles with the zipper



● **Side- and Gable-Walls (Upper Part)**

- Put down the walls
- Insert the Keder into the grooves of the EAVE Purlin ,NO.3 and Gable Purlin NO.6,7

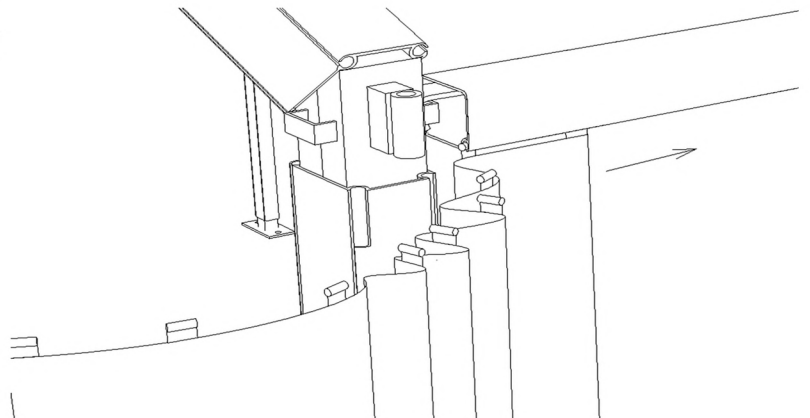

- **Side- and Gable-Walls (Lower Part)**

- Insert the Keder of the lower part of the walls into the groove of the Legs
- Pull downwards with equal force on both sides

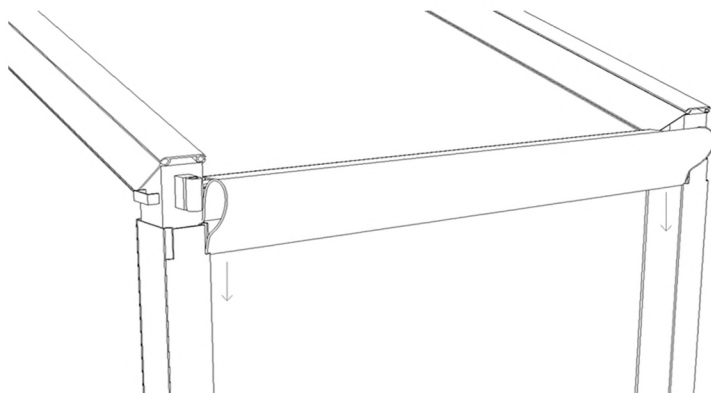

- Insert the strengthen bars(12,13,14) into the groves of Roof-cover,Gable cover.

For Roof cover, drive the NO.18 downwards, together with(15,16,17), NO.17 in the middle, NO.15 and 16 on four corners.



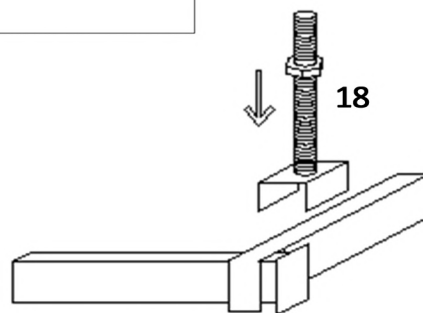
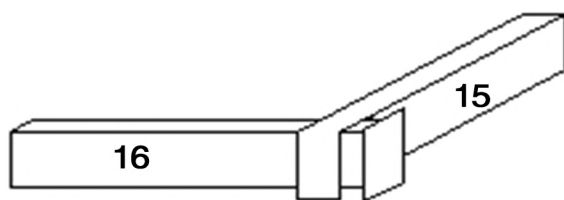
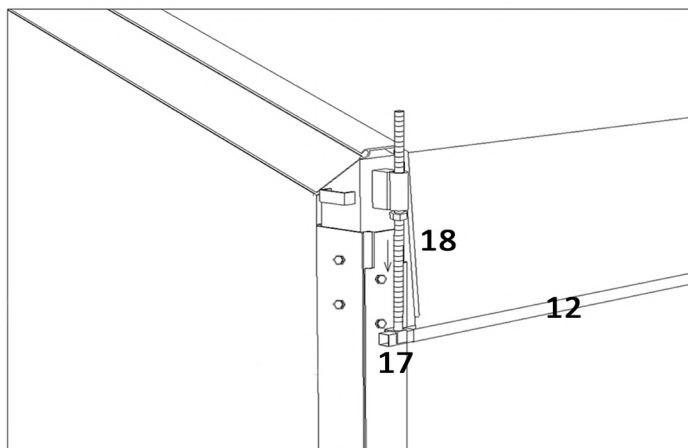



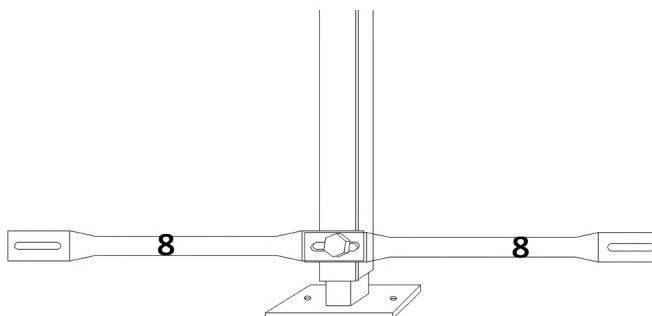

For Gable cover, insert NO.17 into the ring of NO.27 and drive the Tie down, NO.23











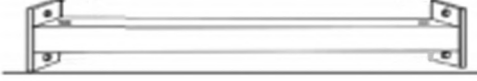



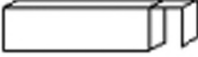
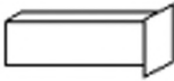



- Insert the bottom bars NO.8 into the groves of the lower part of Side wall and fix it with bolts.











- Bottom bars NO.9 and NO.10 are fixed as NO.8.

Part NO.	Part		9x9m	9x12m	9x15m	9x18m
	Description	Drawing	pcs	pcs	pcs	pcs
1	Roof beam		8	10	12	14
2	Leg, side		8	10	12	14
3	Purlin, eave		6	8	10	12
4	Purlin, roof		15	20	25	30
5	Leg, gable		4	4	4	4
6	Purlin, gable		4	4	4	4
7	Purlin, gable		2	2	2	2
8	Bottom bar side		6	8	10	12
9	Bottom bar gable		4	4	4	4

Part NO.	Part		9x9m	9x12m	9x15m	9x18m
	Description	Drawing	pcs	pcs	pcs	pcs
10	Bottom bar door		2	2	2	2
11	Portal beam		4	4	4	4
12	Strengthen bar side		6	8	10	12
13	Strengthen bar gable		4	4	4	4
14	Strengthen bar door		2	2	2	2
15	Strengthen bar comer		4	4	4	4
16	Strengthen bar comer		4	4	4	4
17	Strengthen bar middle		8	10	12	14
18	Strengthen bar		8	10	12	14

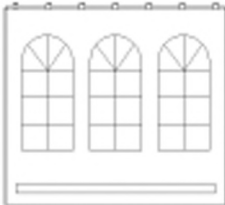
Part NO.	Part		9x9m	9x12m	9x15m	9x18m
	Description	Drawing	pcs	pcs	pcs	pcs
19	Steel fork		1	1	1	1
20	Top connection		4	5	6	7
21	Eave connection		8	10	12	14
22	Foot plate		12	14	16	18
23	Tie down		4	4	4	4
24	Bolt+ nut M12x120		28	30	32	34
25	Bolt+ nut M12x100		24	26	28	30
26	Bolt+ nut M12x70		44	52	60	68
27	Strap		4	4	4	4

Part NO.	Part		9x9m	9x12m	9x15m	9x18m
	Description	Drawing	pcs	pcs	pcs	pcs
28	rope		2	2	2	2
29	Spanner 22-24		2	2	2	2
30	Spanner 27-30		2	2	2	2
31	Flange		4	4	4	4
32	Peg		24	28	32	36
33	Roof		3	4	5	6
34	Gable		2	2	2	2
35	sidewall		6	8	10	12

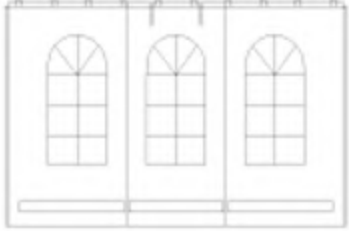
Part NO.	Part		9x9m	9x12m	9x15m	9x18m
	Description	Drawing	pcs	pcs	pcs	pcs
36	sidewall, gable		4	4	4	4
37	Doorwall		2	2	2	2

5. Fundamental

- A. Make sure the surface of the aluminum profiles are glabrous and avoid a damage of the protective layer
- B. The stack height of the aluminum profiles can't exceed 80cm. Otherwise, you should put a crosstie every 80cm height
- C. Please do not modify any aluminum, profile or make any gap or groove on them
- D. During the transportation, the crossties should be put among the aluminum profiles. Avoid heavy weight on the aluminum profiles to cause distortion
- E. To avoid mildews, make sure the fabric is 100% dry when folding it
- F. The covers and walls have to be deposited in their packing sacks. Avoid a damage of the fabrics by friction, fire, dye, etc
- G. Avoid glue on the frame or covers, that will affects the appearance of the tent
- H. When install the covers and walls, make sure that you put it into a protecting foil or carpet to avoid it getting dirty or damaged
- I. Don't loosen the bolts freely. Fix the bolts not too strong but solid. Please tighten them by hands and avoid any damages on the aluminum profile
- J. No flame for barbeque or other events in the tents. (If the temperature is over 70°C, the cover fabric will be distorted)
- K. The frame parts and fabric for Roof, Gable, Cover and Wall should be packed respectively
- L. The tents should be stocked in a dry place
- M. If any fabrics, ropes or frames are damaged, please use the repair kit and spare parts to repair them.

Contact information

Head office:

Dancover A/S
Lyngevej 16A, Nørre Herlev
3400 Hillerød
Denmark

For more information
please visit:

www.dancovershop.com

National contact

Denmark:

denmark@dancover.com

UK:

uk@dancover.com

Germany:

germany@dancover.com

France:

france@dancover.com

Sweden:

sverige@dancover.com

Finland:

suomi@dancover.com

Poland:

polska@dancover.com

Luxembourg:

luxembourg@dancover.com

Portugal:

portugal@dancover.com

Spain:

espana@dancover.com

Italy:

italia@dancover.com

Switzerland:

schweiz@dancover.com

Austria:

austria@dancover.com

Norway:

norge@dancover.com

Nederland:

nederland@dancover.com

Ireland:

ireland@dancover.com

Belgium:

belgique@dancover.com