

DANCOVER[®]

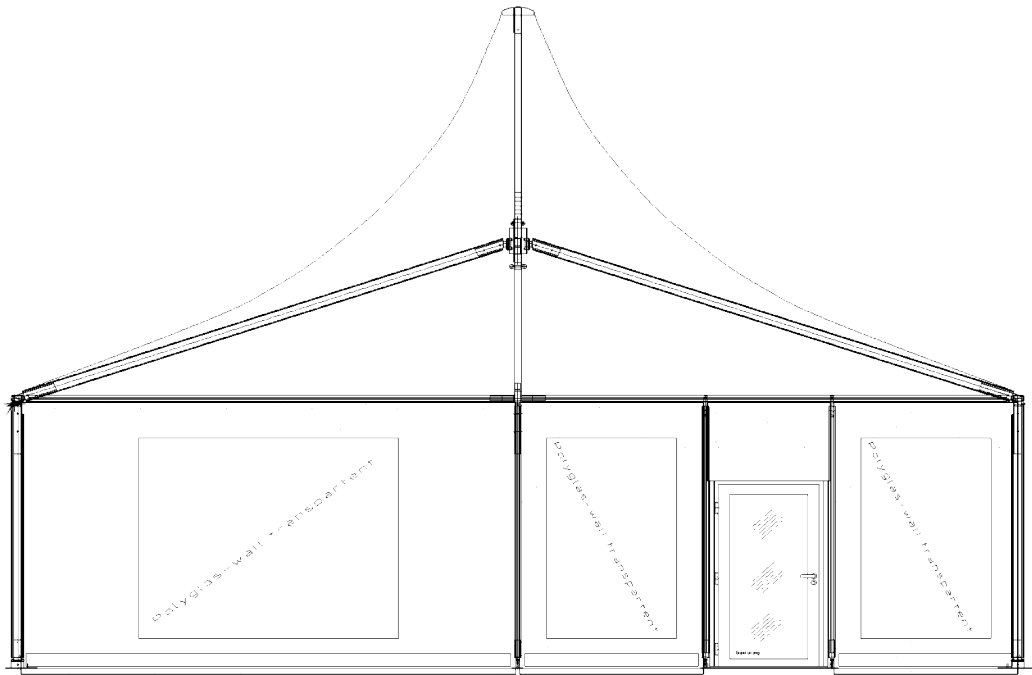

Manual
for
Pagoda Tent PRO+
10x10m EventZone

Set up instructions



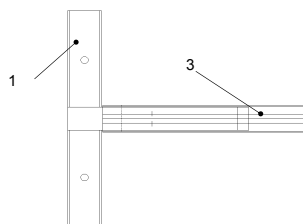
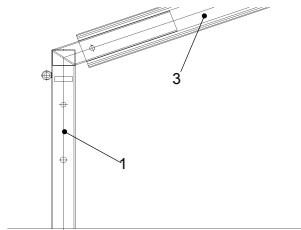
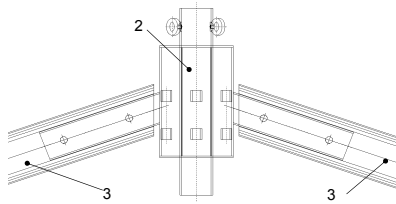
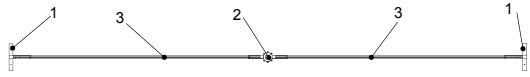
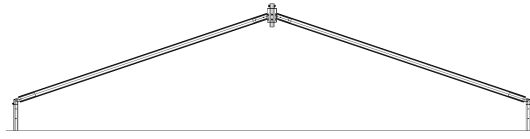

1.) Take the eave-connector (1) and a ridge piece (2), slide the beam (3) over the square tube at the eave-connector (1) on the ridge-piece (2) until it covers the drilling. Fit through the M16x90 bolt and bolt them together

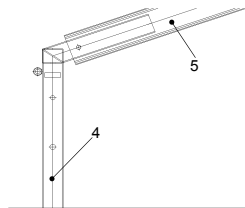
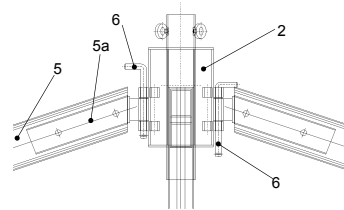
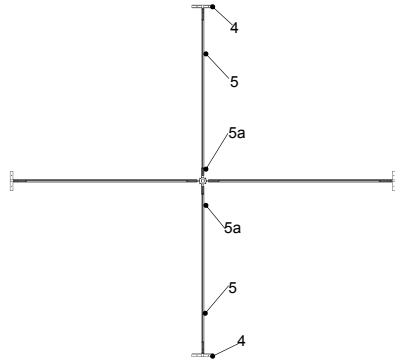
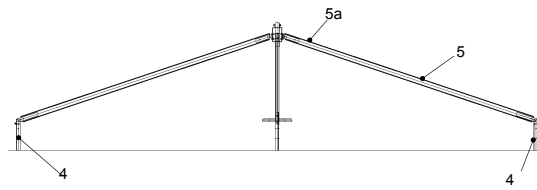

2.) Take the beam (5) with the already fixed inserts (5a). Slide the beam over the square tube at the eave connector (4) until the drill is covered, fix the M16x90 bolt and screw it together. Hang the beam (5) with the insert (5a) onto the ridge-piece (2) by fixing to bolt (6) through the it.

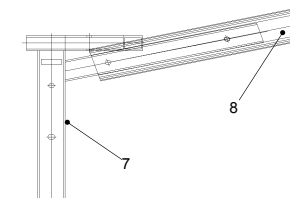
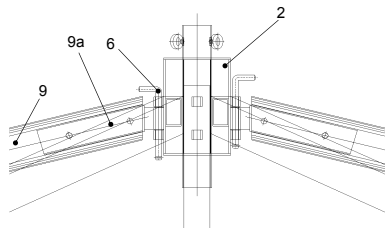
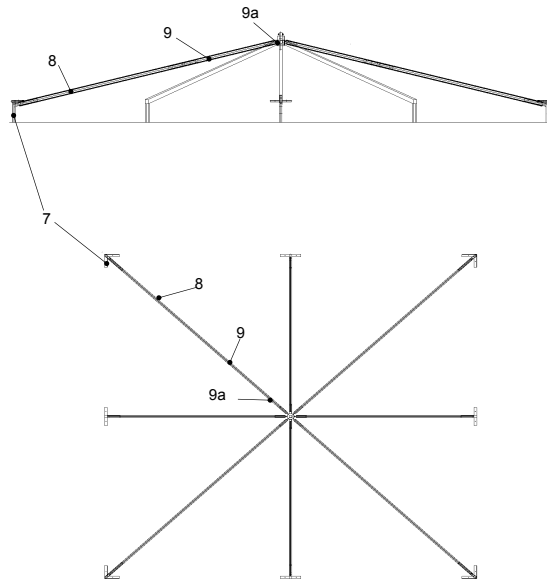

3.) Take the beam (5) with the already fixed inserts (5a). Slide the beam over the square tube at the eave connector (4) until the drill is covered, fix the M16x90 bolt and screw it together. Hang the beam (5) with the insert (5a) onto the ridge-piece (2) by fixing to bolt (6) through the ridge-piece.

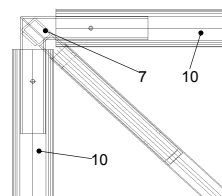
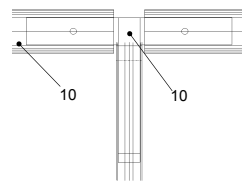
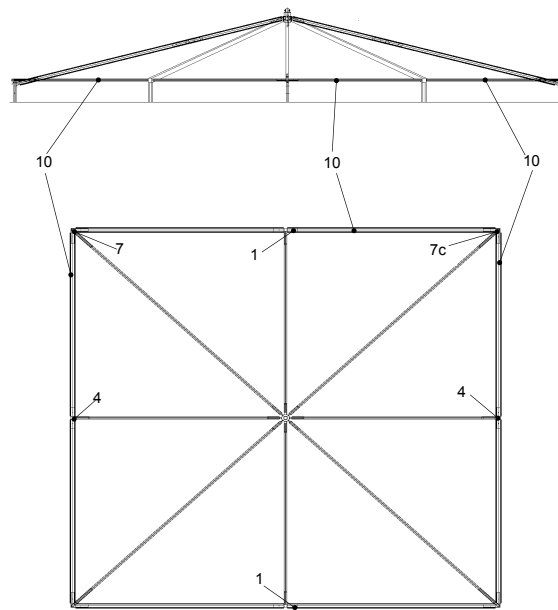

4.) Slide the eave-purlin (10) over the eave-connector (1), (4) and (7) until the drilling is covered, fit the M12x90 bolt and screw them together. In case the eave-purlins (10) can not be slid on the corners, loose the connection at the eave connection (7) to the beam and slide the eave-purlin (10) as well as the beam (8).

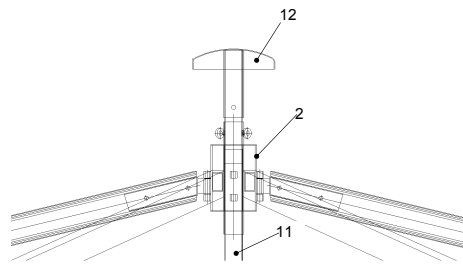
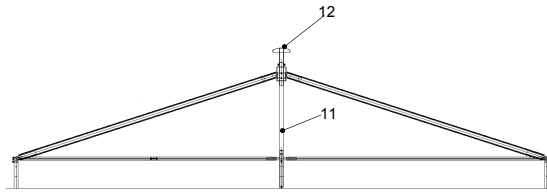
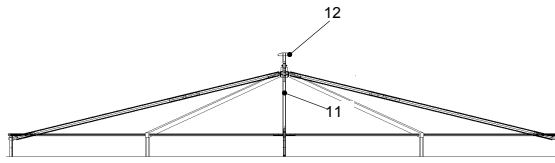

5.) Take the mast (11) and slide it from top into the ridge-piece (2) fix the top-cap (12) over the tube.

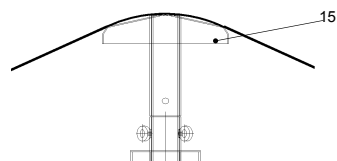
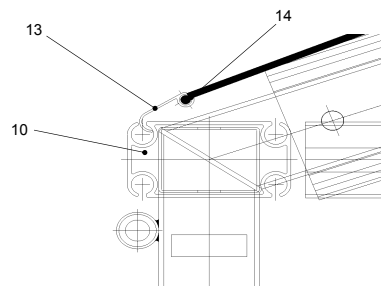
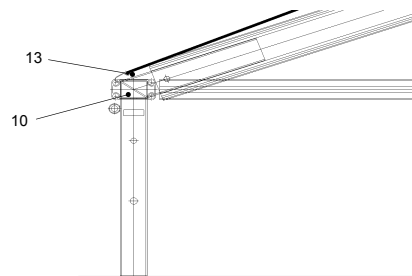
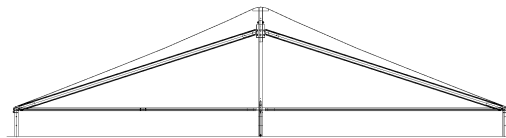
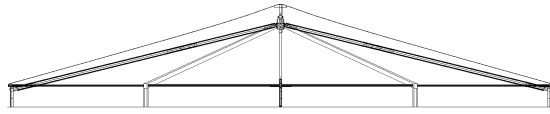

6.) Fit the top-cap (5) over the mast (11). Put the roof cover on the frame. Pull the hooking track device (13) in the channel of the roof cover (14) on all sides. Hook the track (15) in the eave purlin (10).

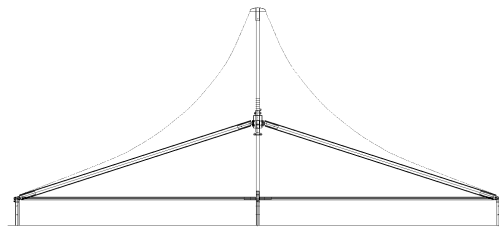
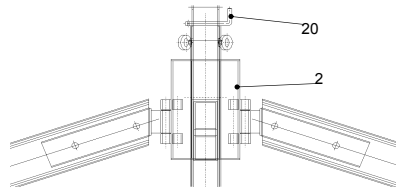
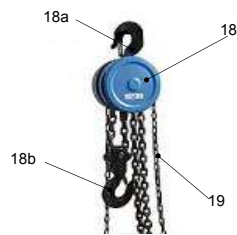
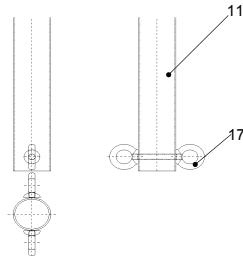
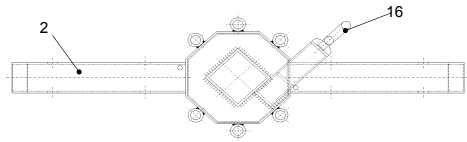

7.) To tension the cover you have to use the pulley (18) by hanging the hook (18a) onto the ring bolt(16). Take the hook (18b) and hang it on the ring bolt (17) on the mast (11), now pull the chained (19) until the requested tension is reached. Fit the bolt (20) into the mast (11), remove the pulley (18).

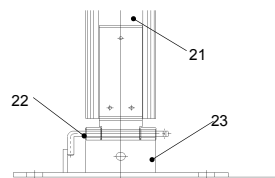
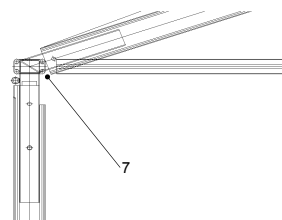
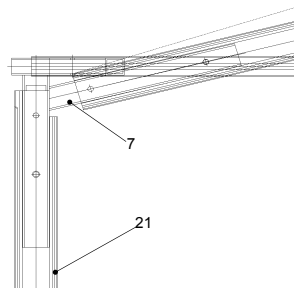
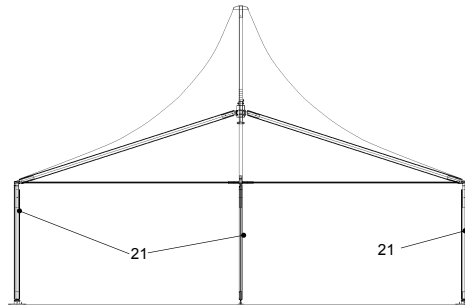
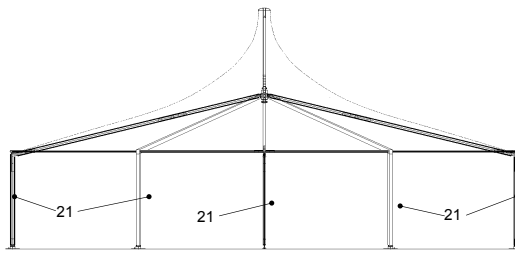

8.) Lift the frame, slide the 8 legs (21) over the eave-connector (1), (4), (7) until the drilling is covers in full. Bolt the connection by use of the M16/90 bolt (22) together. Fix the foot-bolt in the base-plate (23) by. Lower the total frame to the ground.

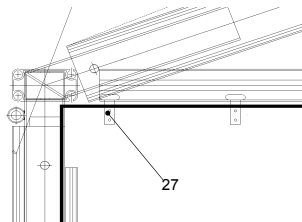
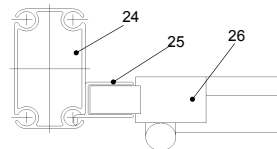
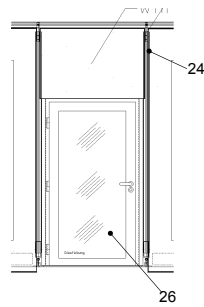
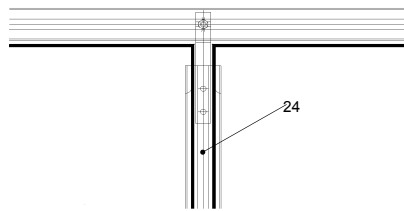
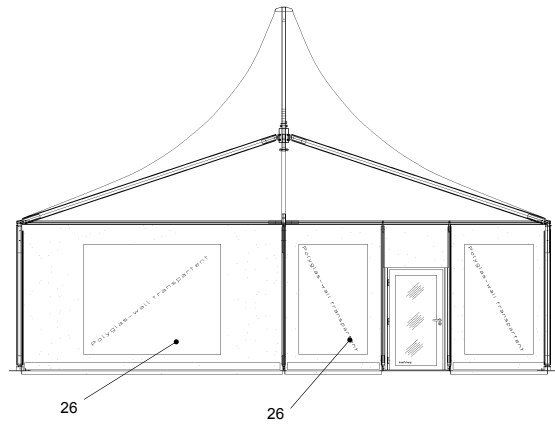

9.) Fit the door-part (24). Fix the walls (27) in. Hook the u-profiles (25) to the door parts (24). Slide the door in the u-profiles, fit the next door-part and fix the 2nd u-profiles and slide it to the door, now you can fasten the door-post to the eave purlin.

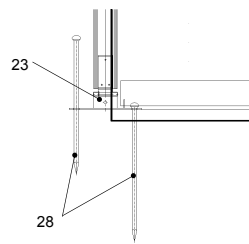
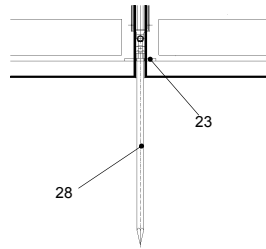
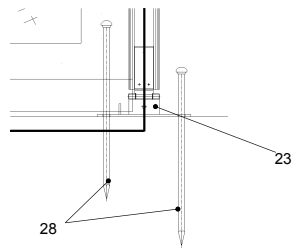
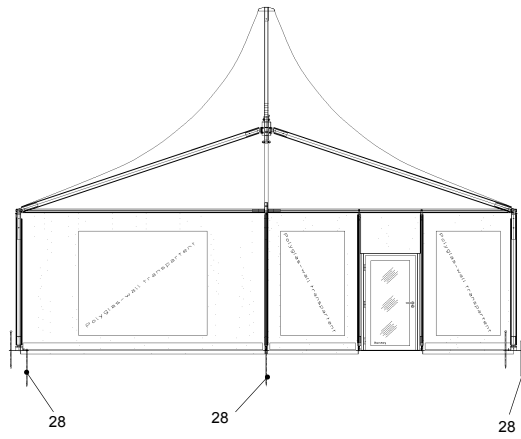

9.) Put the legs straight. Secure the tent by knitting in the anchors to the holes of the baseplate. The pagoda comes with 16 ground-anchors.

DANCOVER[®]

.com

Contact information

Head office:

Dancover A/S
Nordre Strandvej 119 G
3150 Hellebæk
Denmark

For more information
please visit:
www.dancovershop.com

National contact

Denmark: 70 26 76 20
denmark@dancover.com

UK: 020 8099 7570
uk@dancover.com

Germany: 041 0266 7040
germany@dancover.com

France: 0975 181 800
france@dancover.com

Sweden: 040 233 262
sverige@dancover.com

Finland: 0 931 581 720
suomi@dancover.com

Poland: 22 300 8602
polska@dancover.com

Luxembourg: +49 041 0266 7040
luxembourg@dancover.com

Portugal: 308 800 899
portugal@dancover.com

Spain: 911 436 828
espana@dancover.com

Italy: 02 479 21 198
italia@dancover.com

Switzerland: 0840 000125
schweiz@dancover.com

Austria: 0662 626935
austria@dancover.com

Norway: 231 00 690
norge@dancover.com

Nederland: 0 858 880 524
nederland@dancover.com

Ireland: 0 151 33 003
ireland@dancover.com

Belgium: 0 28 08 08 09
belgique@dancover.com