

**DANCOVER<sup>®</sup>**

**.com**

Manual  
for  
Basic Storage Tent  
3,3x4,8m/3,3x6m PE

# DANCOVER<sup>®</sup>

.com

## Safety Advice

### Attention

In some countries approval is needed to set up a tent larger than 75 m<sup>2</sup>. It is your responsibility to comply with local rules and regulations and to ensure that the tent is assembled correctly.

In case of bad weather conditions, it is your responsibility to ensure the tent is safely secured and that the tent does not cause damage to others.

Do not use open fire, welding equipment or other sources which can ignite, inside or close to the tent.

The tent must be safely secured. We recommend you secure your tent with straps and pegs as soon as it is assembled.

Make sure to check if the tent is covered by your home contents insurance.

Tents must be evacuated under extreme weather conditions.

In the event of snow, always remove snow from the roof of the tent regularly to prevent snow from building on the roof, as heavy snow can cause the tent to collapse.

In the event of rain, there is a risk of rain puddles building up on top of the roof of the tent. Heavy rain puddles can cause the roof to collapse. It is your responsibility to ensure rain puddles do not build up. As a precaution, make sure the roof of the tent is stretched out properly and adequately over the side frames of the tent and remove rain water regularly.

Do not unpack or repack your tent in freezing temperatures. In case of temperatures below zero, always unpack and repack your tent indoors to avoid the risk of cracking parts.

The tent must be totally dry before you repack and store it to avoid mildew.

**Note:** Dancover warranty applies only to the normal use of the Product, normal wear and tear excepted, in accordance with written use instructions or manual. The warranty does not apply to damage caused by accident, abuse, misuse, or modification of the Product.

## Warranty Information

Please visit [dancovershop.com](http://dancovershop.com) for information on warranty.

*Please always check our website for the latest safety advice and manual.*

# Assemble manual

## DEAR CUSTOMER







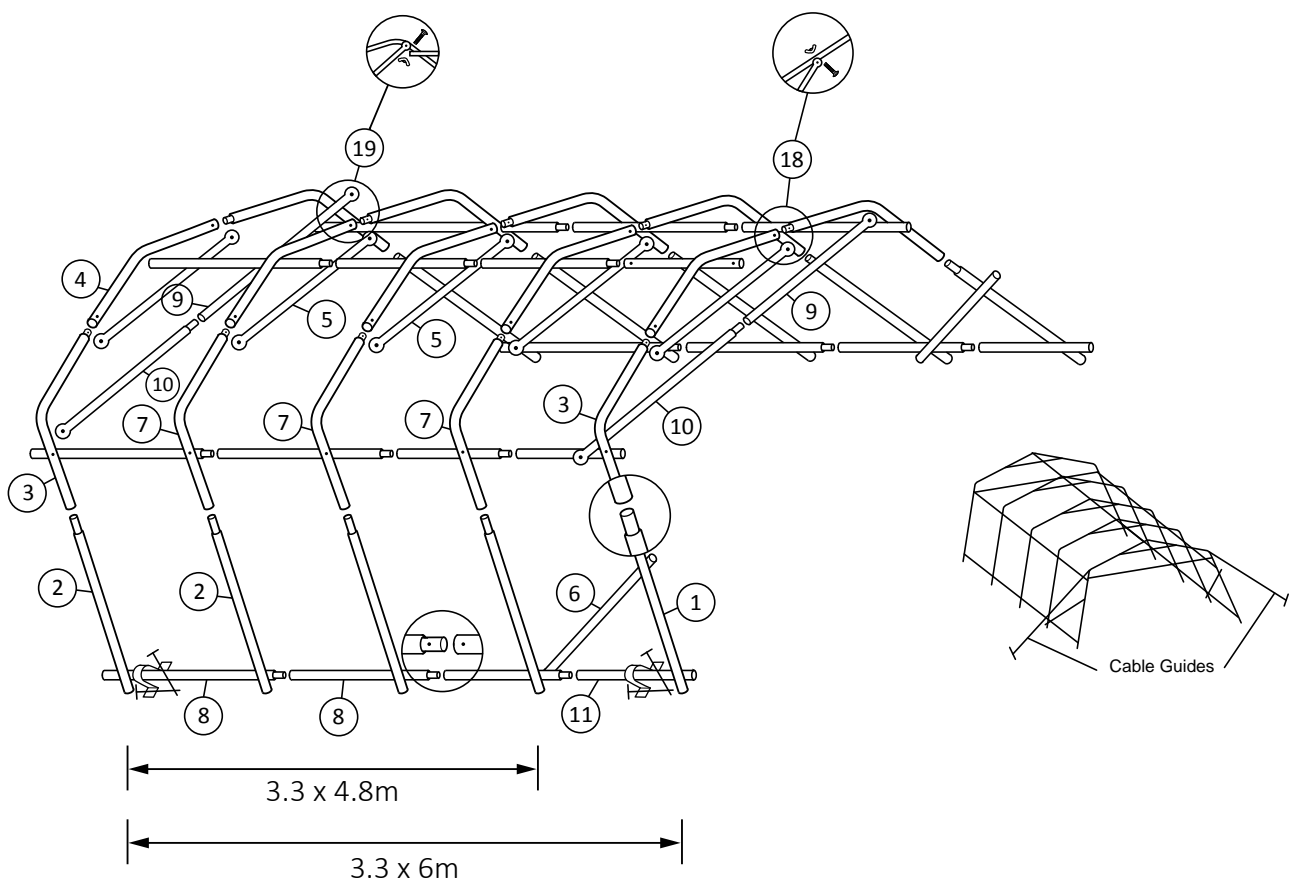



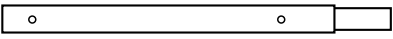
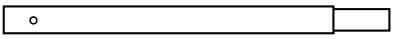

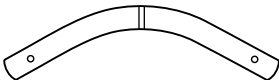
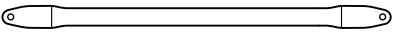
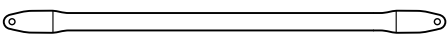
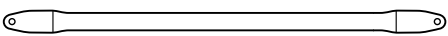
*Assembly with more than one person suggested.*

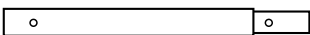
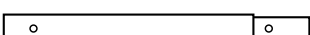
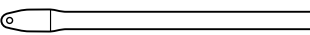
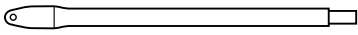
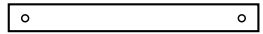
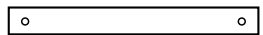
Please use gloves when assembling the metal frame portion of this unit.

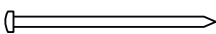
The metal components of this product have been treated with a rust preventive coating that may feel oily to the touch. This coating is not dangerous, but may dirty your hands during assembly. We recommend that you wipe metal parts clean with a mixture of warm water and dish detergent prior to assembly. Should your hands become dirty, simply wash with soap and water.

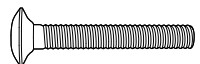

# 3.3m Part List

PART NO.	DESCRIPTION		QTY	
			4.8	6
No.1	Back leg		2	2
No.2	Regular leg		6	8
No.3	End corner arch		4	4
No.4	Center arch		4	5
No.5	Cross bar		4	5
No.6	Diagonal		2	—
No.6-1	Diagonal		—	2
No.7	Main corner arch		4	6
No.8	Connecting pipe		10	—
No.8-1	Connecting pipe		—	15
No.9	Door rail female		2	2
No.10	Door rail male		2	2
No.11	Connecting pipe		5	—
No.11-1	Connecting pipe		—	5
No.12	Guiding cables guide		4	4
No.13	Nail		8	8
No.14	Floor bracket		4	4
No.15	Elastic kit for door		12	12
No.16	Door rail hook		12	12
No.17	S hook		12	12
No.18	1-3/4" Bolt		16	18
No.19	2-1/2" Bolt		22	27

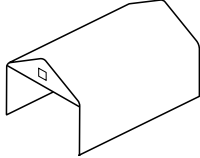
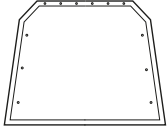
No.20	Wing nut		38	45
No.21	Roof		1	1
No.22	Endwall		2	2

10-09-2018

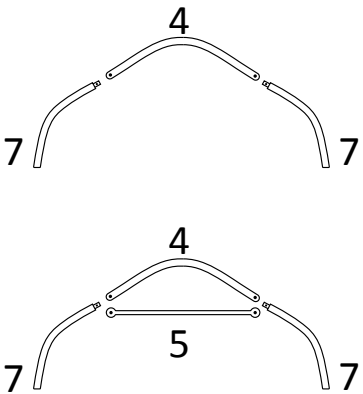
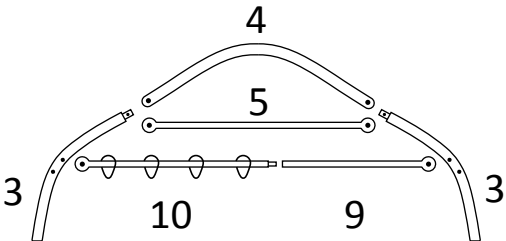
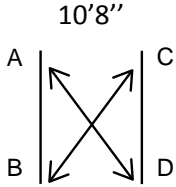
<p><b>1. Assembly of middle arches</b></p> <p>a) Take one arch (No.4); assemble with one main corner arch (No.7) on the left side.</p> <p>b) Take the other corner arch (No.7) on the right side.</p> <p>c) Take one completed arch; put screw 1-3/4" (No.18) through holes on the right side and attach bar (No.5) over screw and tighten wing nut (No.20).</p> <p>d) Repeat same procedures on the left side.</p>	
<p><b>2. Repeat step 1 for the remaining middle arches.</b></p>	
<p><b>3. Assembly of end arches (Wing nuts are always on inside of the shelter)</b></p> <p>a) Take one arch (No.4); assemble with one end corner arch (No.3) on the left side.</p> <p>b) Take the other corner arch (No.3), put 1-3/4" screw through holes on the right side.</p> <p>c) Take one completed arch, put screw 1-3/4" (No.18) through holes on the right side and attach bar (No.5) over screw and tighten wing nut (No.20). Repeat the same procedure on the left side.</p> <p>d) Take one bar (No.9 + No.10) to an end arch (No.3) with one screw 1-3/4" (No.18) and wing nut (No.20).</p> <p>e) Slide the hooks (No.16) over bars then put other side over screw 1-3/4" screws and wing nut (No.20).</p> <p>f) Repeat step 3 with the remaining arch.</p> <p>g) Place one of the last arches assembled at the front of the shelter, the other at the back.</p>	
<p><b>4. Assembly of legs</b></p> <p>a) Assemble legs (No.2) with bottom horizontal bars (No.8) on all sections except for the front section with screw (No.19) and wing nut (No.20).</p> <p>b) Assemble leg (No.1) with bar (No.11) connecting diagonal bar (No.6) with screw 2-1/2" (No.19) with wing nut (No.20).</p> <p>c) Insert leg (No.2) into an end arch (No.3) one side at a time.</p>	

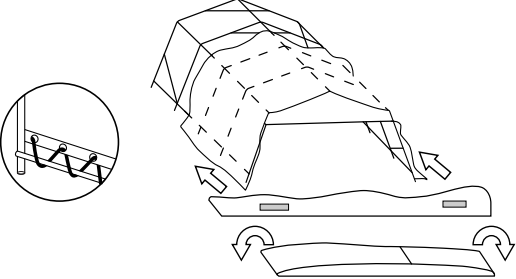
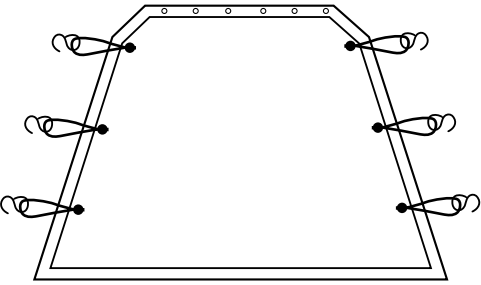
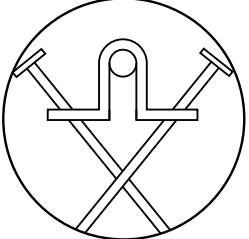
<p>d) Repeat step c) until the whole shelter is completed.</p> <p>e) Make sure the base is open to 10' 8".</p> <p>f) Make sure the distances AD and BC have exactly the same length as per illustration, lengths depends on the model.</p>	
<p><b>5. Cover installation (Ties are always on the inside)</b></p> <p>a) Place the roof in front of the shelter as illustrated.</p> <p>b) Unfold as illustrated then lift onto shelter as is.</p> <p>c) Place cover over the completed structure making sure that the TRIANGLE is at the front of the garage.</p> <p>d) Lace rope through grommets and around pipes tightly going completely around the garage. Grommets are placed in the upper corner of each door. Put the remaining cord through these grommets and secure to the ground with nails.</p> <p>e) Tie firmly inside ties to bars.</p>	
<p><b>6. Door Assembly</b></p> <p>a) Take one door with shiny side facing outside placing on to hooks (No.17).</p> <p>b) Repeat a) for the remaining doors.</p> <p>c) Take the elastic, put it through one of the grommet holes on the door from the inside out. Take S hook, place it on the elastic and squeeze one end with a pair of pliers so it locks on the elastic. Repeat until all the elastics are done, and then use the open end to hook on the grommet band of the roof.</p>	
<p><b>7. Anchoring garage.</b></p> <p>a) Place your garage in the final position you want then close the doors, front and back if supplied before anchoring, anchor with brackets (No.14) and nail (No.13) as per diagram on the first page. Drive anchor into ground.</p> <p>b) Fix flap to your house (if applicable).</p>	

# DANCOVER<sup>®</sup>

.com

## Contact information

### Head office:

Dancover A/S  
Nordre Strandvej 119 G  
3150 Hellebæk  
Denmark

For more information  
please visit:  
[www.dancovershop.com](http://www.dancovershop.com)

## National contact

Denmark: 70 26 76 20  
[denmark@dancover.com](mailto:denmark@dancover.com)

UK: 020 8099 7570  
[uk@dancover.com](mailto:uk@dancover.com)

Germany: 041 0266 7040  
[germany@dancover.com](mailto:germany@dancover.com)

France: 0975 181 800  
[france@dancover.com](mailto:france@dancover.com)

Sweden: 040 233 262  
[sverige@dancover.com](mailto:sverige@dancover.com)

Finland: 0 931 581 720  
[suomi@dancover.com](mailto:suomi@dancover.com)

Poland: 22 300 8602  
[polska@dancover.com](mailto:polska@dancover.com)

Luxembourg: +49 041 0266 7040  
[luxembourg@dancover.com](mailto:luxembourg@dancover.com)

Portugal: 308 800 899  
[portugal@dancover.com](mailto:portugal@dancover.com)

Spain: 911 436 828  
[espana@dancover.com](mailto:espana@dancover.com)

Italy: 02 479 21 198  
[italia@dancover.com](mailto:italia@dancover.com)

Switzerland: 0840 000125  
[schweiz@dancover.com](mailto:schweiz@dancover.com)

Austria: 0662 626935  
[austria@dancover.com](mailto:austria@dancover.com)

Norway: 231 00 690  
[norge@dancover.com](mailto:norge@dancover.com)

Nederland: 0 858 880 524  
[nederland@dancover.com](mailto:nederland@dancover.com)

Ireland: 0 151 33 003  
[ireland@dancover.com](mailto:ireland@dancover.com)

Belgium: 0 28 08 08 09  
[belgique@dancover.com](mailto:belgique@dancover.com)