

MODULARO™

WOODEN DOUBLE GARAGE VAASA 7,8x5,2x3,21m

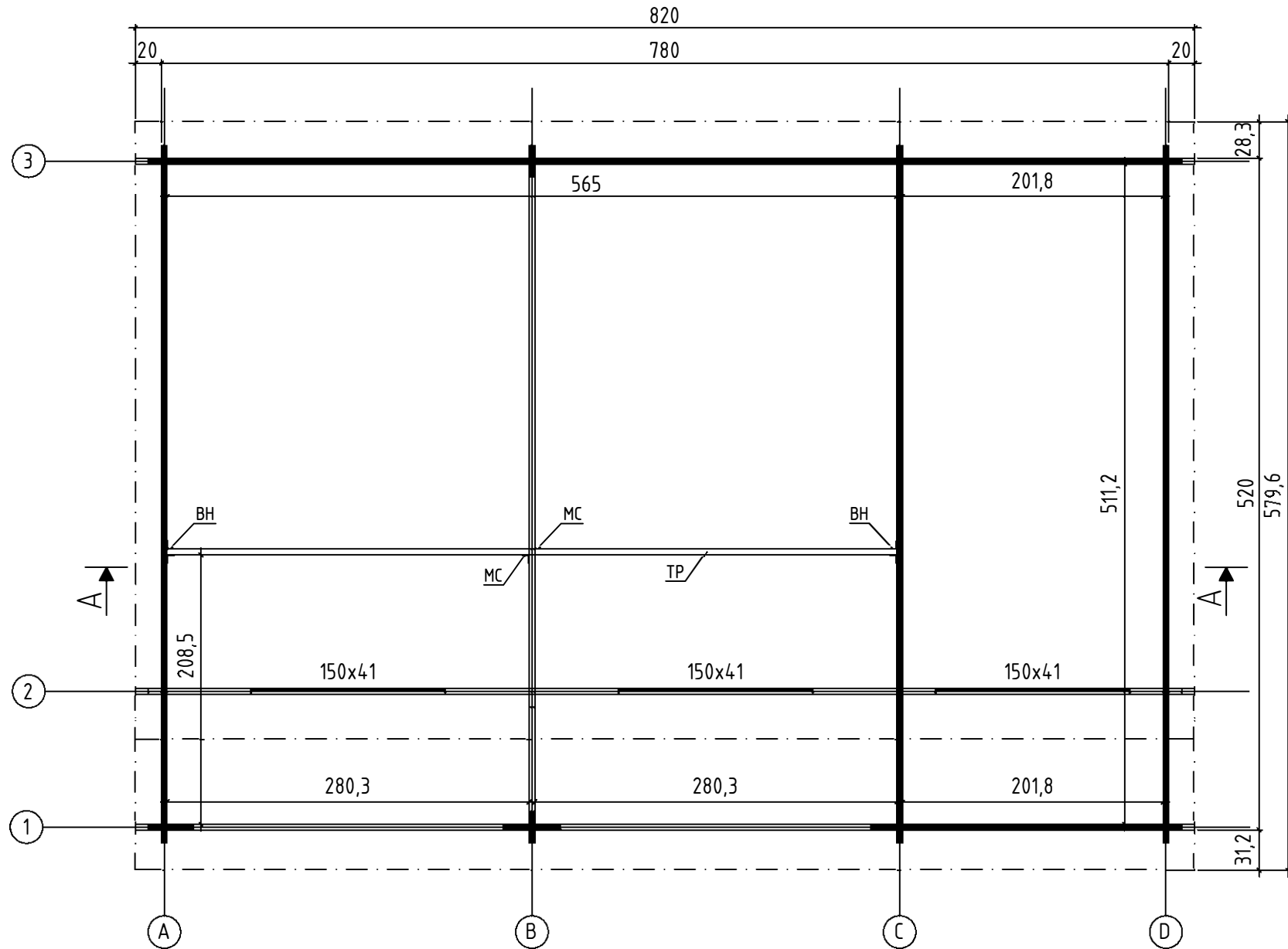

Art.Nr. WC165110
 Groundplan - Grundplan - Plan de masse - Planimetria - Plattegrond - Põhiplaan



Art.Nr. WC165110

Foundation - Fundament - Fondation - Fundamenta -Fundering - Immutatud alusraam

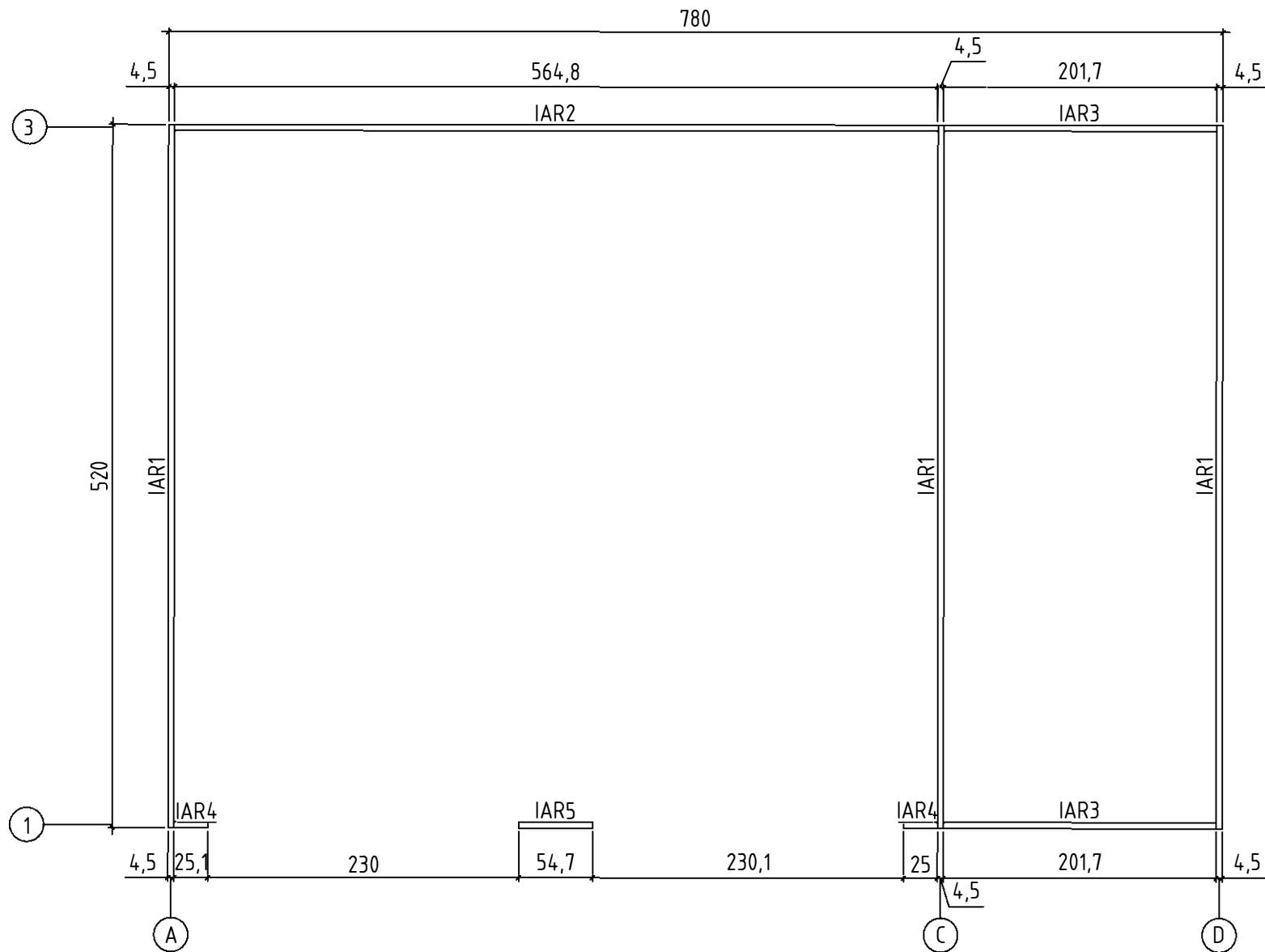

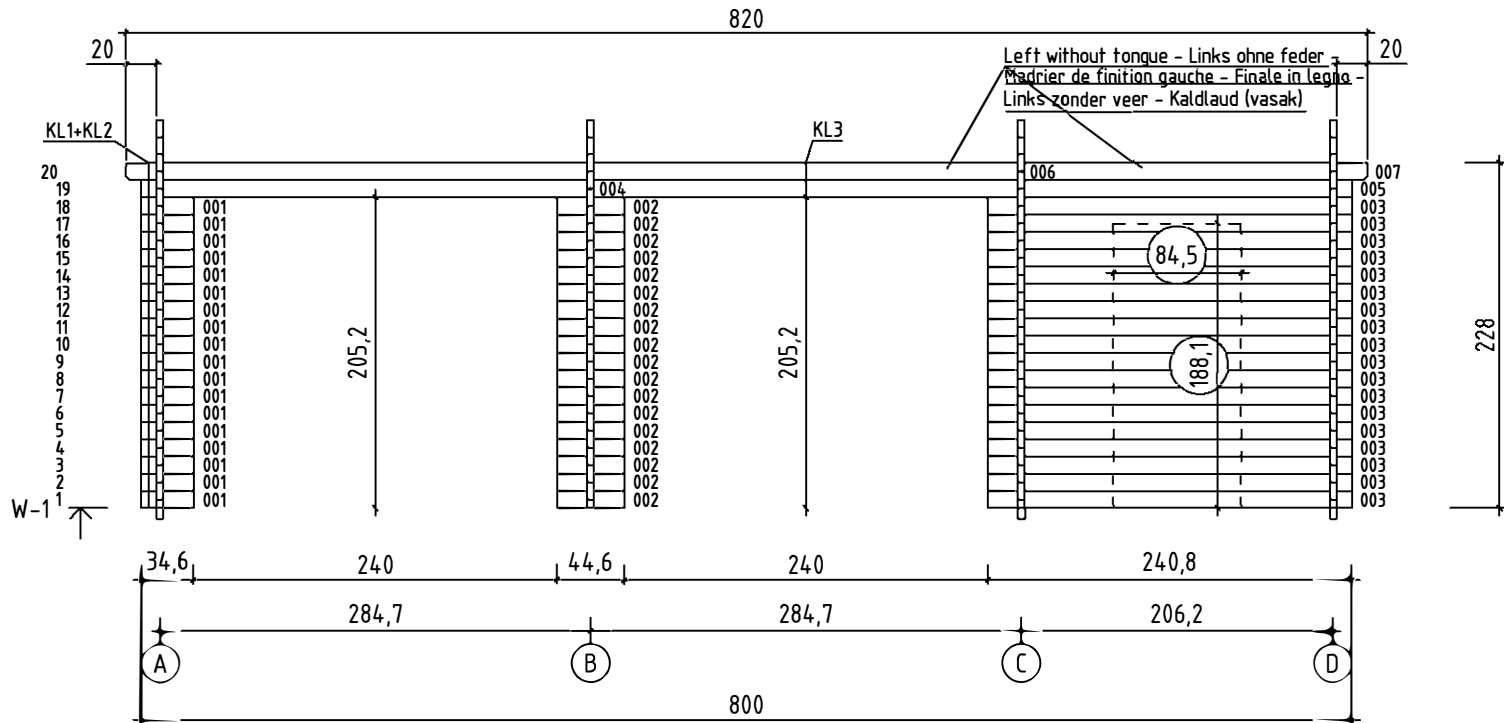

A single door and has been delivered together with the building. You can choose the location for the door by yourself by cutting the wall logs as shown in the picture (see the dotted line).

Im lieferumfang ist eine einzeltür sowie ein einzelfenster enthalten. Dafür sind aber werksseitig keine aussparungen vorgesehen so dass sie sowohl fenster als auch tür individuell verbauen können. eine anleitung hierfür entnehmen sie bitte der montageanleitung (siehe bild).

Le positionnement de la porte de service nécessite la découpe préalable des madriers. Veuillez respecter les cotes de découpes dans les madriers indiquées sur le schéma. vous pouvez positionner, selon votre convenance, les ouvertures de chaque côté ou à l'arrière du garage.

Una portaa singola e' stata consegnata con la casa. Tu puoi scegliere la posizione della porta e/o finestra secondo il tuo gradimento, tagliando la parete come raffigurato nella fotografia (segui la linea tratteggiata).

Bij uw huisje is een losse enkele deur geleverd. U heeft hierin een vrije keuze waar u deze wilt inbouwen, door het inzagen van de wandbalk zoals op de tekening (zie de stippellijn).

Majakomplekt sisaldab üksikust, mille asukoht on võimalik ise valida. Ukseava tuleb lõigata joonisel näidatud mõõtudes (vaadake punktiir jooni).

Art.Nr. WC165110

Recht without tongue - Recht ohne feder -
 Madrier de finition droit - Finale in legno -
 Rechts zonderveer - Kaldlaud (parem)

Recht without tongue - Recht ohne feder -
 Madrier de finition droit - Finale in legno -
 Rechts zonderveer - Kaldlaud (parem)

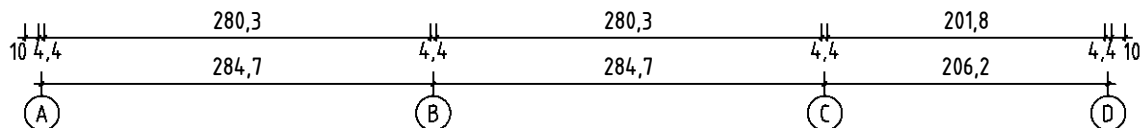
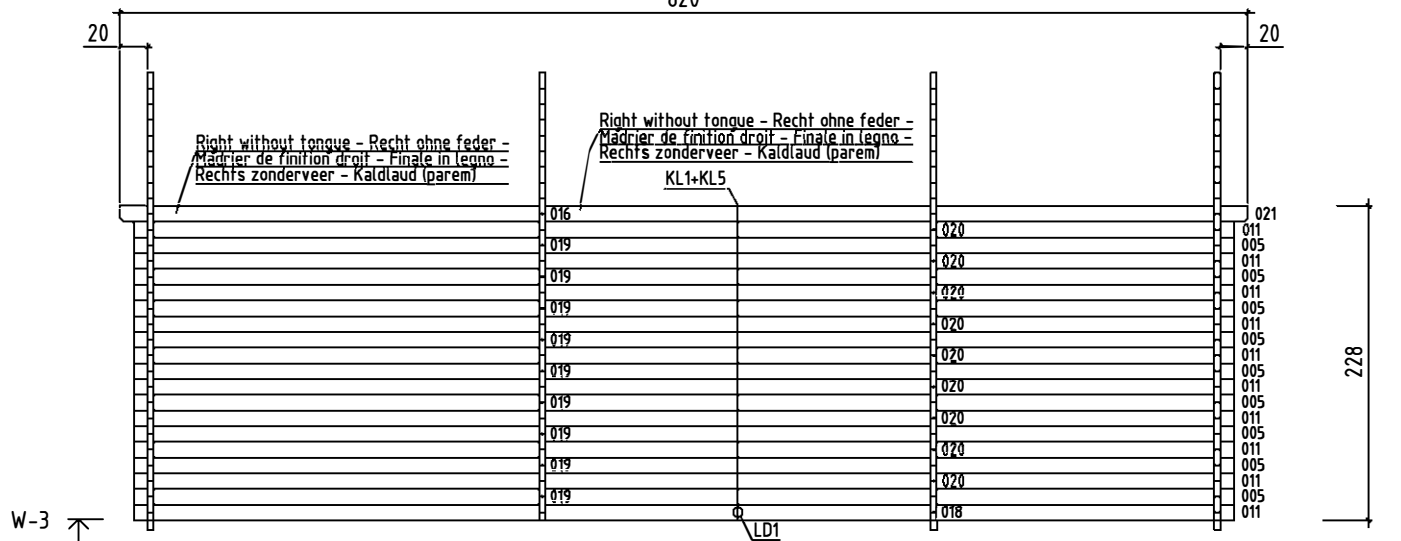
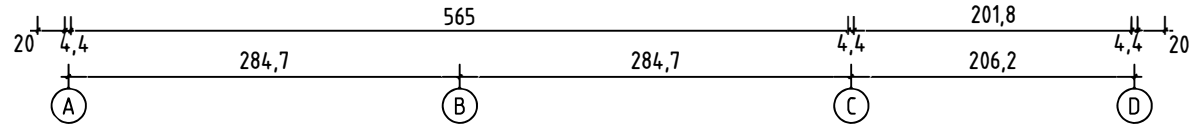
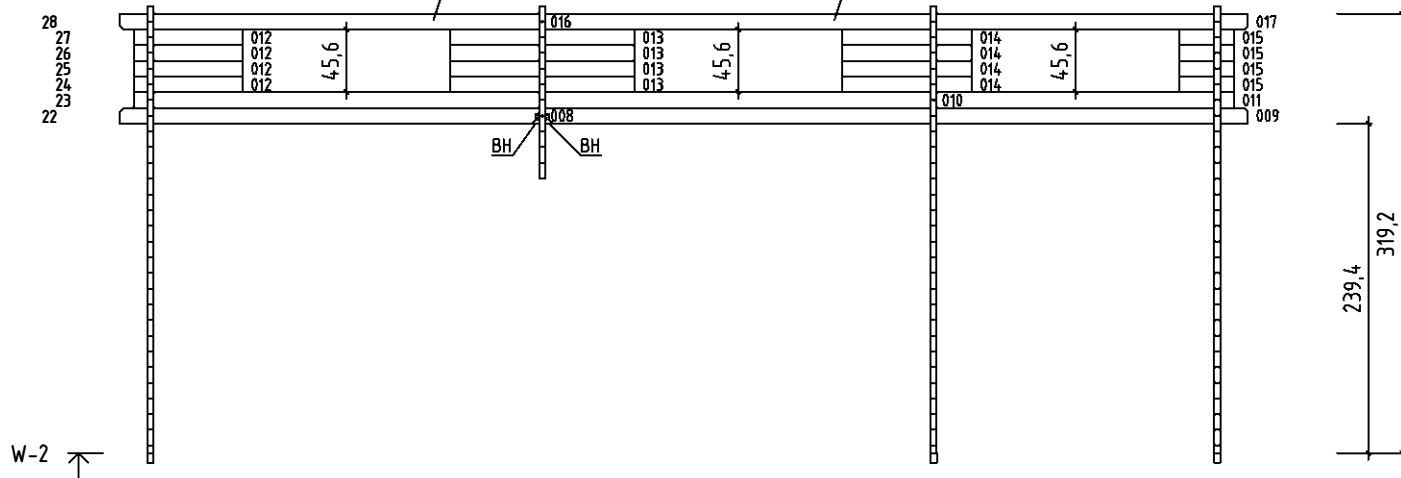

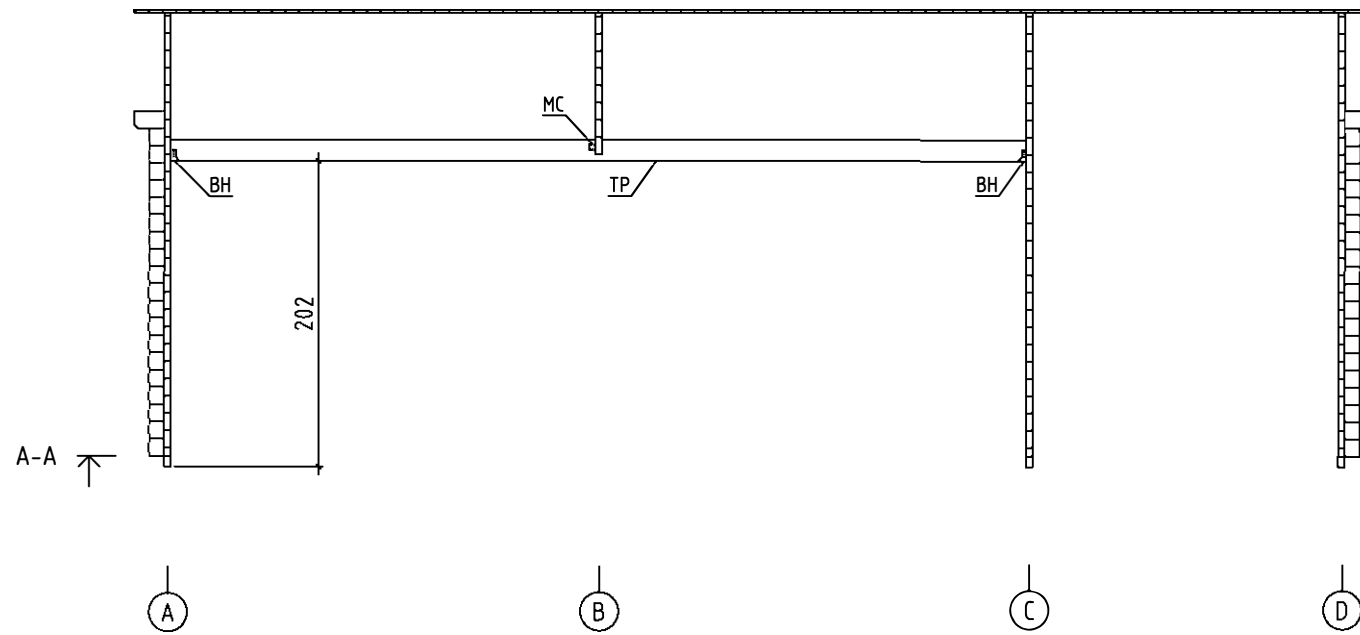

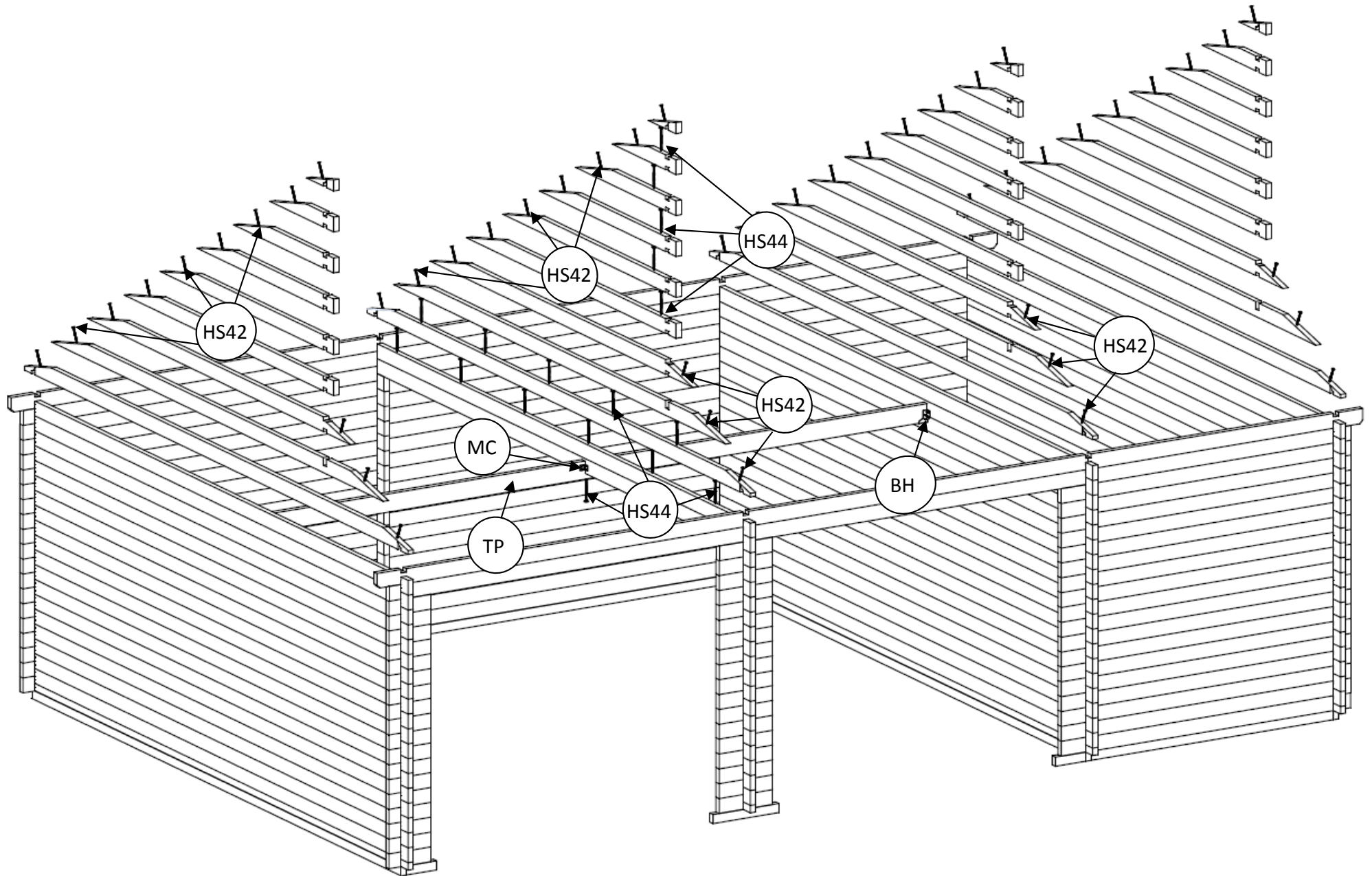

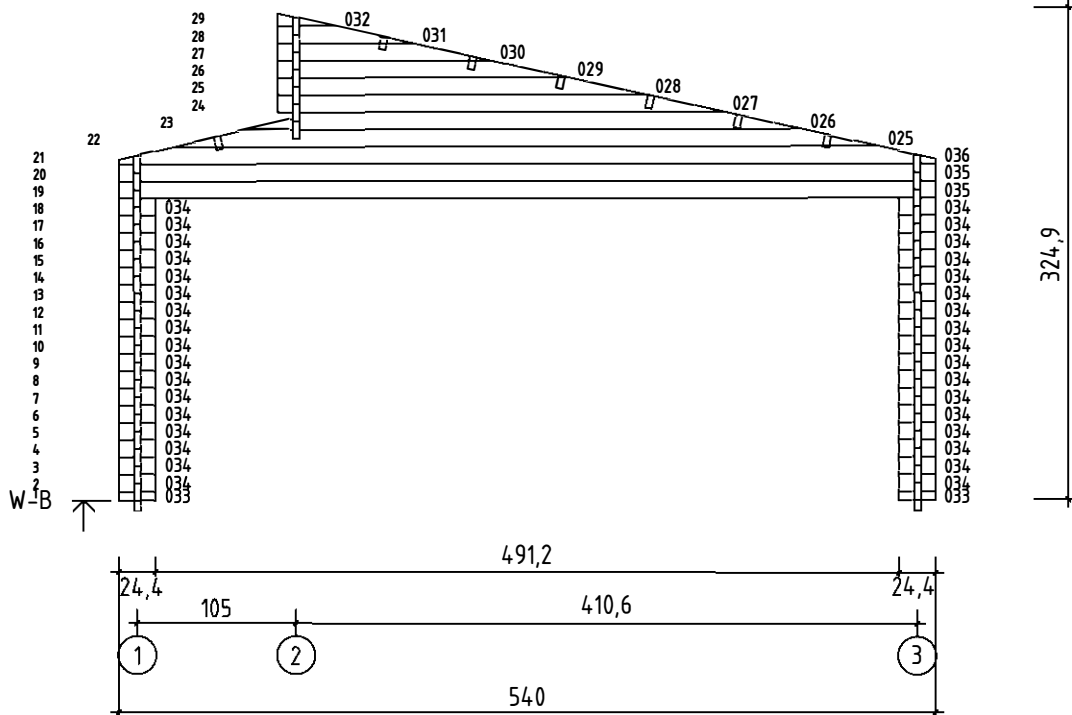
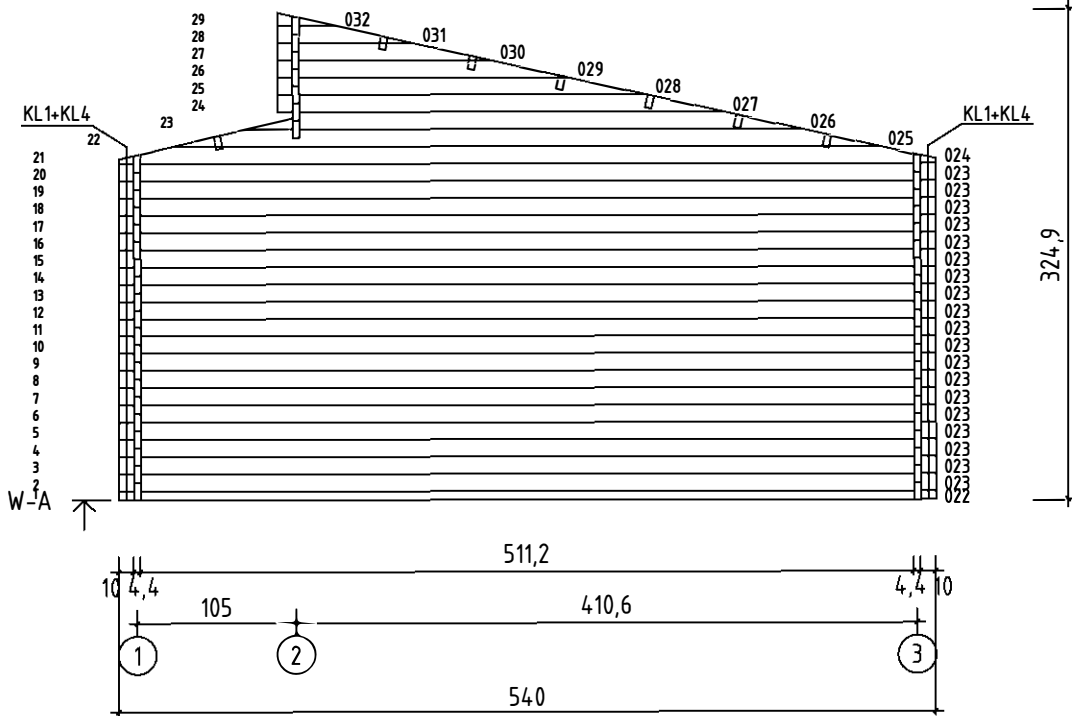

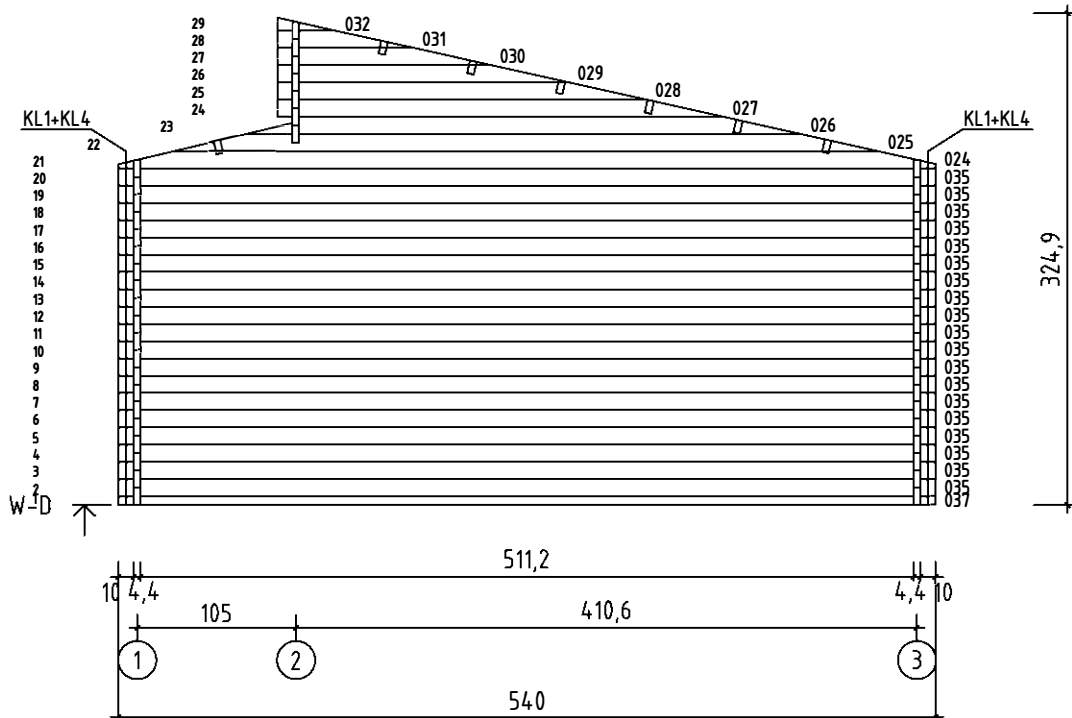
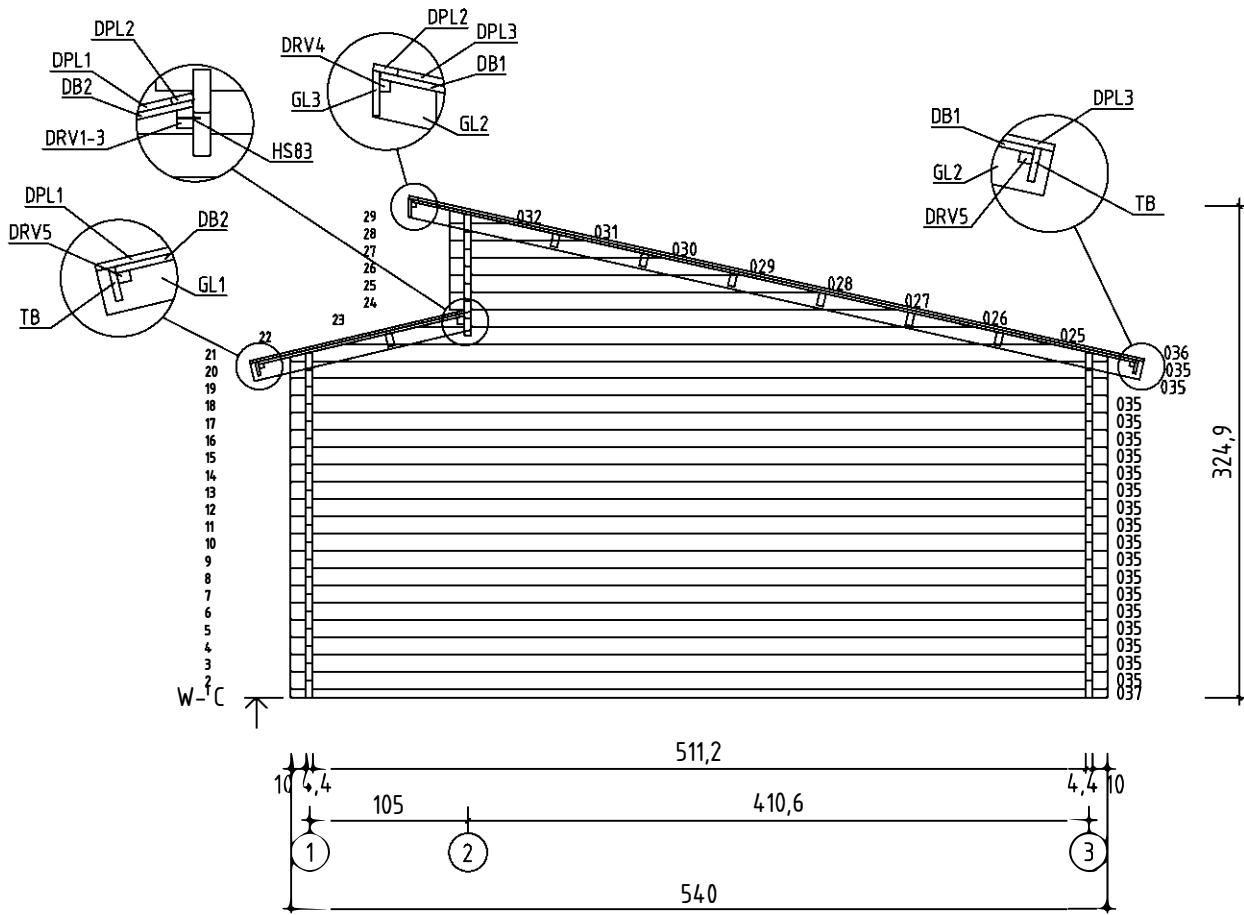



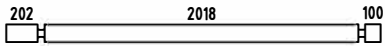
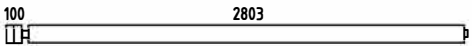



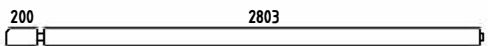

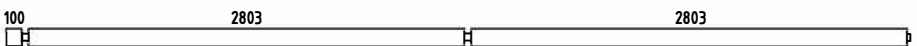

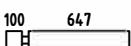
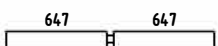
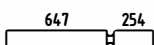



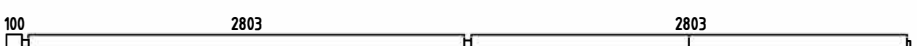
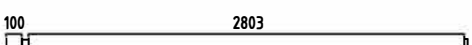
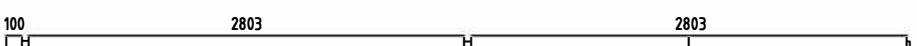

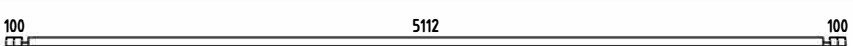





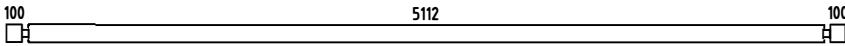
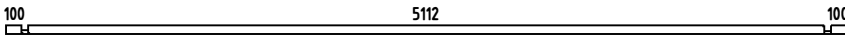
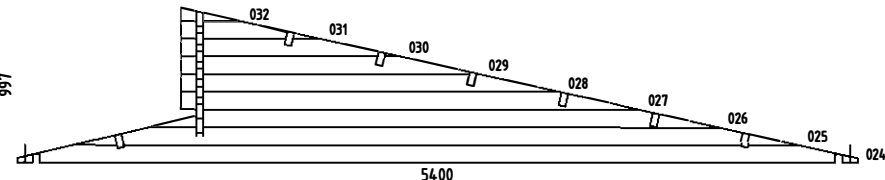
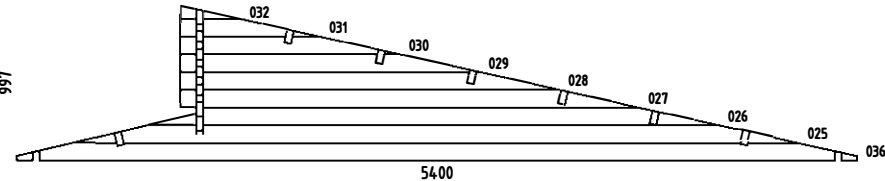
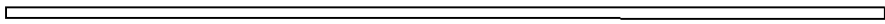
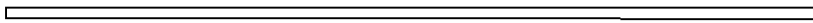
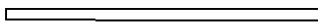

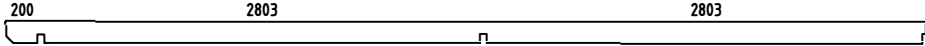
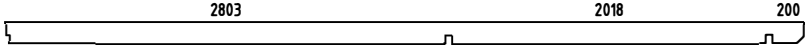
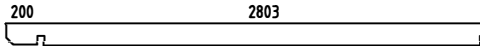
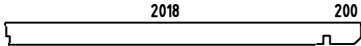
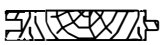

Pos	26.01.2018 Piece list - Stückliste - Liste des pièces - Elementi - Stuklijst - Tükítabel Art.Nr. WC165110	10/13	Q	P (mm)	L (mm)
001			18	44x114	346
002			18	44x114	446
003			18	44x114	2408
004			1	44x114	2969
005			10	44x114	5031
006			1	44x114	5916
007			1	44x114	2284
008			1	44x114	3069
009			1	44x114	5131
010			1	44x114	5816
011			11	44x114	2184
012			4	44x114	791
013			4	44x114	1338
014			4	44x114	945
015			4	44x114	398
016			2	44x114	3069
017			1	44x114	5131
018			1	44x114	5816
019			9	44x114	2969
020			9	44x114	5816
021			1	44x114	5131
022			2	44x57	5400
023			38	44x114	5400





Pos	26.01.2018	Piece list - Stückliste - Liste des pièces - Elementi - Stuklijst - Tükítabel Art.Nr. WC165110	11/13	Q	P (mm)	L (mm)
033				2	44x57	244
034				34	44x114	244
035				21	44x114	5400
037				1	44x57	5400
WA-1 WD-1				1 1		
WB-1 WC-1				1 1		
IAR2	Foundation - Fundament - Fondation - Fondamenta - Fundering - Immutatud alusraam 			1	45x70	5648
IAR1	Foundation - Fundament - Fondation - Fondamenta - Fundering - Immutatud alusraam 			3	45x70	5200
IAR3	Foundation - Fundament - Fondation - Fondamenta - Fundering - Immutatud alusraam 			2	45x70	2017
IAR5	Foundation - Fundament - Fondation - Fondamenta - Fundering - Immutatud alusraam 			1	45x70	547
IAR4	Foundation - Fundament - Fondation - Fondamenta - Fundering - Immutatud alusraam 			2	45x70	251
A-PR1	Roof beam - Dachbalken - Panne de toit - Perlina del tetto - Gordingen / dakbalk - Pärilin 			3	44x140	5916
A-PR4	Roof beam - Dachbalken - Panne de toit - Perlina del tetto - Gordingen / dakbalk - Pärilin 			4	44x140	5131
A-PR3	Roof beam - Dachbalken - Panne de toit - Perlina del tetto - Gordingen / dakbalk - Pärilin 			4	44x140	3069
A-PR2	Roof beam - Dachbalken - Panne de toit - Perlina del tetto - Gordingen / dakbalk - Pärilin 			3	44x140	2284
DB1	Roof boards - Dachbretter - Voliges - Perlina per tetto - Dakhout - Katuselaud 			92	90x18	4900
DB2	Roof boards - Dachbretter - Voliges - Perlina per tetto - Dakhout - Katuselaud 			92	90x18	1400
DRV1	Wall finishing board - Abschlussbohle - Madrier supérieur de finition - Assi di finitura della parete - Wand afdekplaat - Kald-poollaud 			2	44x57	200
DRV2	Wall finishing board - Abschlussbohle - Madrier supérieur de finition - Assi di finitura della parete - Wand afdekplaat - Kald-poollaud 			1	44x57	2016

Pos	26.01.2018 Piece list - Stückliste - Liste des pièces - Elementi - Stuklijst - Tükítabel Art.Nr. WC165110	12/13	Q	P (mm)	L (mm)
DRV3	Wall finishing board - Abschlussbohle - Madrier supérieur de finition - Assi di finitura della parete - Wand afdekplaat - Kald-poollaud		2	44x57	2801
DRV4	Roof edge reinforcement - Dachrandverstärkung - Corniere de renfort de bord de toit - Rinforzo x tetto - Dakrand versterking - Kald-räästatugevdus		2	28x34	4100
GL3	Gable moulding - Giebelleiste - Planche de rive - Finitura per frontale e retro del tetto - Gevellijst - Kald-viululaud		2	18x120	4100
DPL1	Roofing felt fillet - Dachpappenleiste - Baguette de fixation du feutre bitumeux - Asse per fissaggio guaina bituminosa - Afdekljst asfaltpapier - Katusepapiilist		2	18x58	1455
DPL2	Roofing felt fillet - Dachpappenleiste - Baguette de fixation du feutre bitumeux - Asse per fissaggio guaina bituminosa - Afdekljst asfaltpapier - Katusepapiilist		4	18x58	4060
DPL3	Roofing felt fillet - Dachpappenleiste - Baguette de fixation du feutre bitumeux - Asse per fissaggio guaina bituminosa - Afdekljst asfaltpapier - Katusepapiilist		2	18x58	4975
KL5	Treaded rod m10 - Gewindestange m10 - Tige filetée m10 - Barra filettata passo m10 - Draadstang 10m - Keermelatt		1		220
KL3	Treaded rod m10 - Gewindestange m10 - Tige filetée m10 - Barra filettata passo m10 - Draadstang 10m - Keermelatt		1		260
KL4	Treaded rod m10 - Gewindestange m10 - Tige filetée m10 - Barra filettata passo m10 - Draadstang 10m - Keermelatt		4		300
KL2	Treaded rod m10 - Gewindestange m10 - Tige filetée m10 - Barra filettata passo m10 - Draadstang 10m - Keermelatt		1		310
KL1	Treaded rod m10 - Gewindestange m10 - Tige filetée m10 - Barra filettata passo m10 - Draadstang 10m - Keermelatt		6		2000
TB-1	Fascia board - Traufbrett - Bandeau de toit - Finitura lati tetto - Gevellijst - Räästalaud		4	18x90	4100
DRV-1	Roof edge reinforcement - Dachrandverstärkung - Corniere de renfort de bord de toit - Rinforzo x tetto - Dakrand versterking - Räästatugevdus		4	28x34	4100
TP	Support beam for gate frame - Stutzbohle für torzarge - Madrier de support du cadre de la porte basculante - Asse di supporto per il telaio della porta - Steunpaal voor poort-/ deurkozijn - Tugipuu		1	44x140	5648
GL1	Gable moulding - Giebelleiste - Planche de rive - Finitura per frontale e retro del tetto - Gevellijst - Viululaud		2	18x120	1500
GL2	Gable moulding - Giebelleiste - Planche de rive - Finitura per frontale e retro del tetto - Gevellijst - Viululaud		2	18x120	4975
LD1	Lid for treaded rod hole - Abdeckung für gewindestangenöffnung - Couvercle pour acces réglagé tige filetée - Copeerchio per foro barra filettata - Afdekprofiel voor draadstang - Kaas keermelatil avale		1	18x120	
KL4	Lengthening bolt for treaded rod - Verlängerungsmutter für gewindestange - Manchon de raccordement de tige filetée - Bulloñe per barra filettata passo - Extensie moer voor draadstang - Jätikumutter keermelatil		6	D10	
KL1	Drive nut treaded rod - Ein Schlagmutter für gewindestange - Écrou a frapper pour tige filitée - Dado guida per barra filettata - Aandrijfmoer / aanslagmoer voor draadstang - Löökmutter keermelatil		7	D10	
KL2	Nut for treaded rod - Mutter für gewindestange - Écrou pour tige filetée - Dado per barra filettata - Moer voor draadstang - Mutter keermelatil		7	D10	
KL3	Plain washer treaded rod - Unterlegscheibe für gewindestange - Rondelle plate pour tige filetée - Rondella per barra filettata - Sluitring voor draadeind - Seib keermelatil		7	D10	
HS14	Screw for roof edge reinforcement - Schrauben für dachrandverstärkung - Vis pour fixation corniere renfort de bord de toit - Viti x rinforzo bordo tetto - Schroef voor dakrand versterking - Kruv kald-poollauale		23	4.5x80	
HS12	Screw for metal corner - Holzschraube für metallwinkel - Vis de fixation des cornieres en métal - Viti per fissare squadra di metallo di giunzione - Schroef voor metalen hoek - Krui nurgikule		16	4x40	

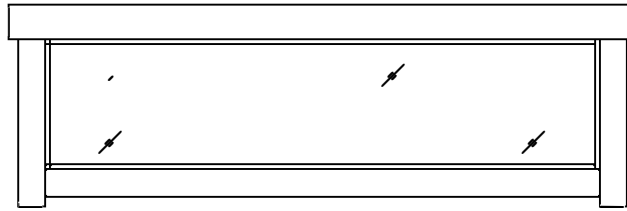
Pos	29.11.2017 Piece list - Stückliste - Liste des pièces - Elementi - Stuklijst - Tükitabel 1500x410 AK.1.100.TSM0.k SGC	1/1	Q	P (mm)	L (mm)
-----	--------------------------------------------------------------------------------------------------------------------------	-----	---	-----------	-----------

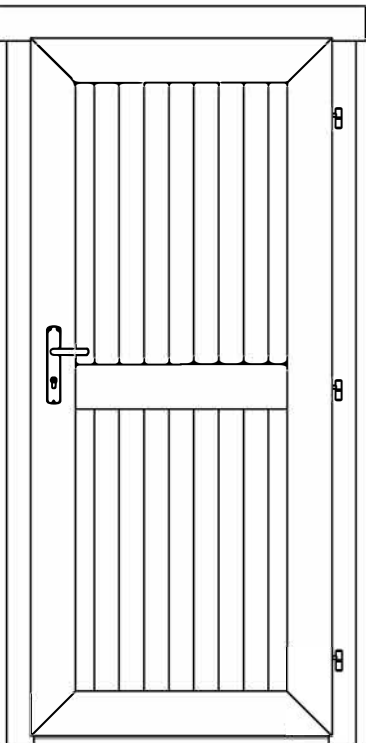
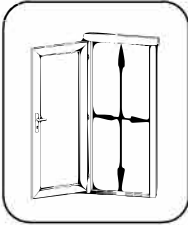
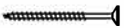
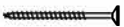
Glass size - Glasgröße - Taille de la vitre - Misura del vetro - Glas afmeting - Klaasi mõõt: 1420x330 mm

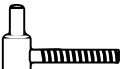

Pos	05.12.2017 Piece list - Stückliste - Liste des pièces - Elementi - Stuklijst - Tükítabel 835x1850 UL.2.100.IVP.MMa TC	1/1	Q	P (mm)	L (mm)
				735x1768 mm	
HS25	Screw for doorstep - Schrauben für swelle - Vis pour fixation barre de seuil - Vite per soglia della porta - Schroef voor deurdorpel - Kruvi lävepakule		2	4.5x65	
HS16	Screw for door jamb - Schraube für türrahmen - Vis de fixation partie haute avec montants du cadre de porte - Viti x fissaggio montanti porte - Schroef voor deurkozijn - Kruvi ukse lengile		4	5x90	
TL4	Door handle fittings - Türgriff - Poignée de porte - Maniglie - Deurhendel / klink - Ukse käepide		1		
TL5	Set of door lock covers - Schlossblenden - Set de garnitures de porte - Copertura serrature - Slot sluitplaat set - Ukse lukuplaat		1		
	Cylinder lock - Zylinderschloss - Barillet de porte - Serratura - Cylinder slot - Ukse lukusüdamik		1	30x35	
	Male bolt hinge for door - Türband - Partie male de paumelle de porte - Cerniera anube x porta - Scharnier bout - Ukse polthing isane		3		

Contact information

Austria



Belgium



Croatia



Denmark



Estonia



Finland



France



Germany



Ireland



Italy



Latvia



Lithuania



Nederland



Norway



Poland



Portugal



Spain



Sweden



Switzerland



UK

